



# 65th MEN'S AND 48th WOMEN'S DIXIE DEAF BOWLING ASSOCIATION

HOSTED BY  
**LOUISVILLE SILENT BOWLING**



IN  
**KINGPIN LANES**  
**9525 TAYLORSVILLE ROAD**  
**JEFFERSONTOWN, KENTUCKY**  
AND  
**RAMADA PLAZA**  
**9700 BLUEGRASS PARKWAY**  
**LOUISVILLE, KY.**

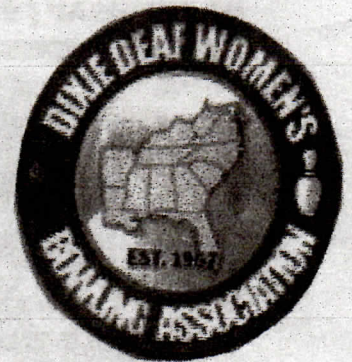

**MAY 29 - 30 - 31, 2015**

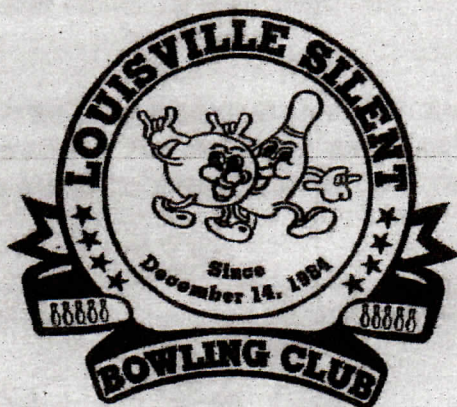



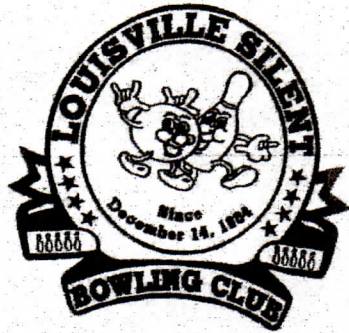

# LOUISVILLE SILENT BOWLING CLUB HISTORY

BY PRESIDENT ROLAND FAIRFAX

I HAVE BEEN PRESIDENT OF THIS ORGANIZATION FOR 30 YEARS AND STILL AM.

THE LOUISVILLE SILENT BOWLING CLUB IS AN ORGANIZATION OF BOWLER MEMBERS AND HAS BEEN GOING STRONG SINCE DECEMBER 14, 1984. THE SURNAME IS L.S.B.C.

THE FIRST ESTABLISHMENT NAME IN 1984 WAS GREATER LOUISVILLE BOWLING ASSOCIATION OF THE DEAF ( G.L.B.A.D. ). IT STARTED WITH A SMALL NUMBER OF BOWLERS AND OFFICERS.



THEN A FEW YEARS LATER THE NAME WAS CHANGED TO LOUISVILLE CARDINAL SILENT BOWLERS ( L.C.S.B. ) IT AS MAINLY FOR BOWLERS ONLY.

IN 1993 THE NAME AGAIN CHANGED TO LOUISVILLE SILENT BOWLING CLUB ( L.S.B.C. ) IT GAINED THE OFFICERS OR BOARD TO 25 AND CONTINUES TO BE A MEMBERSHIP OF BOWLERS ONLY.

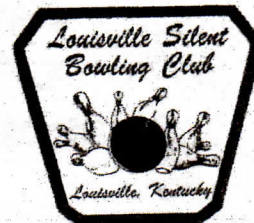

IN 2000 THE ROUND CHANGE TO LOUISVILLE SILENT BOWLING CLUB ( L.S.B.C. ) IT GAINED THE OFFICERS OR BOARD TO 20 AND CONTINUES TO BE A MEMBERSHIP OF BOWLERS ONLY.

IN 2015 THE LOVE FACE BALL & PIN AND STARS CHANGE FROM BALL WITH PINS LOUISVILLE SILENT BOWLING CLUB ( L.S.B.C. ) IT GAINED THE OFFICERS OR BOARD TO 22 AND CONTINUES TO BE A MEMBERSHIP OF BOWLERS AND HELP. SEE LOGO AT BOTTOM.

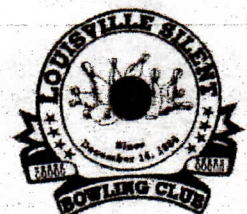



OFFICE OF THE MAYOR  
LOUISVILLE, KENTUCKY

GREG FISCHER  
MAYOR

May 5, 2015

Dixie Deaf Bowling Association

Dear Friends:

Welcome to Louisville – we are delighted and honored that you are visiting us.

Our city will roll out the red carpet and do everything possible to make you feel at home. You will find that we are a friendly and vibrant city, offering one-of-a-kind attractions, great food, and endless opportunities to have fun.

Louisville is home to world-class arts, award winning restaurants, top-notch hotels and more than 120 attractions, many of which can only be experienced here. Our most popular attractions include: The KFC Yum! Center, Kentucky Kingdom Thrill Park, Churchill Downs, the Muhammad Ali Center, the Louisville Slugger Museum, the Kentucky Bourbon Trail®, and the Big Four Bridge at Waterfront Park. We encourage you to explore “Possibility City”, where there’s something for everyone.

Thank you for making Louisville your destination - we hope you’ll come back soon.

Sincerely,

Greg Fischer  
Mayor

[WWW.LOUISVILLEKY.GOV](http://WWW.LOUISVILLEKY.GOV)

LOUISVILLE METRO HALL 527 WEST JEFFERSON STREET LOUISVILLE, KENTUCKY 40202 502.574.2003





## **KENTUCKY WELCOMES YOU ALL FROM THE GENERAL CHAIRMAN**

**ON BEHALF OF THE TOURNAMENT AND ITS SPONSOR LOUISVILLE SILENT BOWLING CLUB, I EXTEND TO EACH OF YOU A SPECIAL WELCOME TO THE 65th MEN'S AND 48th WOMEN'S DIXIE DEAF BOWLING ASSOCIATION TOURNAMENT IN JEFFERSONTOWN, KY. THE HOME OF OUR FAMOUS KENTUCKY DERBY. A LONG STRETCH OF RED CARPET FILLED WITH KENTUCKY HOSPITALTY IS SPREAD FOR YOU AND I HOPE THAT YOU WILL MAKE YOURSELF AT HOME IN OUR BLUEGRASS STATE.**

**MY HEARTFELT THANKS GO TO OUR HARD WORKING COMMITTEE FOR THEIR WILLINGNESS TO GIVE THEIR LABOR AND VAULABLE TIME TOWARD THIS GIGNATIC TOURNAMENT. THEY DESERVE SINCERE THANKS FOR A JOB WELL DONE.**

**MANY, MANY THANKS TO THE D.D.B.A. AND D.D.W.B.A. OFFICERS FOR THEIR INVAULABLE ADVICE AND ENCOURAGEMENT; TO FRIENDS AND THE ORGANIZATIONS IN AND OUT OF KENTUCKY FOR THEIR DONATIONS, ADVERTISEMENT SUPPERT.**

**TO THE BOWLERS, THANKS FOR COMING TO LOUISVILLE TO MAKE THIS BOWLING TOURNAMENT A SUCCESSFUL ONE. GOOD LUCK AND MAY EVERY BOWLER WIN OR LOSE, RETURN HOME SAFELY WITH MEMORIES WORTH MAKING THE TRIP.**

**AND LAST, MAY EVERYONE HERE ENJOY THEIR STAY DURING THOSE TOURNAMENT DAYS AND TREASURE THEM AS PAST FOND MEMORIES.**

**ROLAND FAIRFAX**



**GENERAL CHAIRMAN**





---

## **THURSDAY MAY 28, 2015**

3:00 P.M. DDBA & DDWBA EXECUTIVE BOARD COMMITTEES  
MEETING AT THE TRIPLE CROWN PAVILLION  
CONFERENCE CENTER  
(LOCATED BEHIND THE HOTEL)

7:00 P.M. ROLAND FAIRFAX MASTER  
9:00 P.M. 8 TOP QUALIFIERS

7:00 P.M. DIXIE DEAF WOMEN TAP 9  
9:00 P.M. TOP 5 BOWLERS STEP LADDER  
AT KINGPINS LANES

---

## **FRIDAY MAY 29, 2015**

9:00 A.M. MAGGIE HIPP QUEEN  
1:00 P.M. DDWBA SENIOR CITIZEN QUEEN  
AT KINGPINS LANES

9:00 A.M. ROBERT KOLB MASTER  
1:00 P.M. JOHN ETHRIDGE SENIOR CITIZEN  
AT KINGPINS LANES

6:00 P.M. DDBA & DDWBA MEETING  
9:00 P.M. KINGO GAMES  
AT THE TRIPLE CROWN PAVILLION  
CONFERENCE CENTER  
(LOCATED BEHIND THE HOTEL)

---

## **SATURDAY MAY 30, 2015**

9:00 A.M. DDWBA TEAM EVENT  
1:00 P.M. DDWBA DOUBLES EVENT  
AT KINGPINS LANES

9:00 A.M. DDBA TEAM EVENT  
1:00 P.M. JOHN ETHRIDGE SENIOR CITIZEN  
AT KINGPINS LANES

6:30 P.M. TEXAS HOLD'EM  
7:00 P.M. BALLROOM  
AT THE TRIPLE CROWN PAVILLION  
CONFERENCE CENTER  
(LOCATED BEHIND THE HOTEL)

---

## **SUNDAY MAY 31, 2015**

9:00 A.M. DDWBA SINGLES EVENTS  
AT KINGPINS LANES

9:00 A.M. DDBA SINGLES & DOUBLES EVENTS  
AT KINGPINS LANES

---





ROLAND FAIRFAX  
CHAIRMAN



CHERYL SPURLOCK  
REGISTRATION

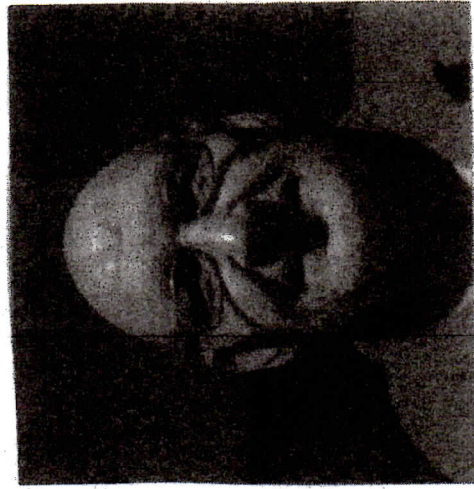

DONALD McMONIGLE  
TREASURER



RICKY SPURLOCK  
CO - CHARMAN





**TAMMY EATON  
LADIES CHAIRMAN**



**SUZANNE MAYES  
PUBLICITY**



**OSCAR HAMILTON  
SENIORS CHAIRMAN**



**MARK HUNT  
FUND RAISER**



**COMMITTEE**

**WOMEN ROW R - L: SHERRY POLLARD, BETH GARDNER, PEARLINE MOLET, DIERDRE ALKIER, JEANI TUCKER  
MEN ROW R - L: ERIC LUNDGREN, LEE POLLARD, MATT GARDNER, THOMAS SMITH, HERY MOLET**

**NO PICTURE MIKE GRAY, TERESA BURNETTE, OWEN CALLAHAN**

**2015  
68th MEN'S AND 51st WOMEN'S  
DIXIE DEAF BOWLING ASSOCIATION  
COMMITTEE**

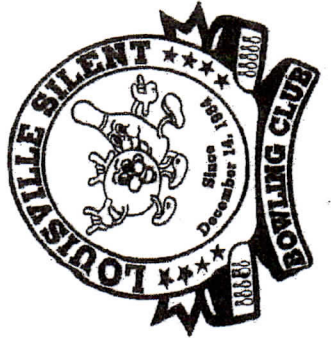



## **DIXIE DEAF BOWLING ASSOCIATION**

**It is our pleasure to warmly welcome all bowlers and fans to our 65<sup>th</sup> Annual of DDDBA tournament in Louisville, KY.**

**We would like to extend a special thanks to Louisville Silent Bowling Club and their committees for hard works to make a successful host the weekend, so we hope you have a great time at this tournament and bring back to home safely.**

**Hope all of you join us at Fairmont, West Virginia in June 2016. The event is coming 2017 to honor Dixie Deaf Women Bowling Association 50<sup>th</sup> Anniversary and will announcement more details shortly.**

**It is showing that we are in very strong organization.**

**May you have many strikes, spares, and win the prizes, too...**

**Warmly feeling by officers,**

**Robert Chain, Jr. President**

**Timothy Martin, Vice-President**

**Lawson McNally, Secretary & Treasurer**



# OFFICERS OF DIXIE DEAF BOWLING ASSOCIATION

YEAR	CITY / STATE	PRESIDENT	VICE PRESIDENT	SECRETARY/ TREASURER
1951	ATLANTA, GA.	TODD HICKS	HENRY OAKS	CHARLES McNEILLY
1952	BIRMINGHAM, ALA.	CHARLES McNEILLY	TODD HICKS	HENRY OAKS
1953	JACKSONVILLE, FLA.	TODD HICKS	N/A	CHARLES McNEILLY
1954	MIAMI, FLA.	W. J. SCOTT	RUSH LETSON	CHARLES McNEILLY
1955	ATLANTA, GA.	W. J. SCOTT	RUSH LETSON	CHARLES McNEILLY
1956	BIRMINGHAM, ALA.	RUSH LETSON	DOUGLAS CUMBLE	CHARLES McNEILLY
1957	LOUISVILLE, KY.	RUSH LETSON	B. WARREN	CHARLES McNEILLY
1958	JACKSONVILLE, FLA.	RUSH LETSON	B. WARREN	CHARLES McNEILLY
1959	MIAMI, FLA.	CHARLES McNEILLY	RUSH LETSON	L.B. WARREN
1960	BIRMINGHAM, ALA.	CHARLES McNEILLY	RUSH LETSON	L.B. WARREN
1961	ATLANTA, GA.	SAM RITTENBERG	TODD HICKS	MAURICE SAMPLES
1962	ATLANTA, GA.	DON TURNER	SAM RITTENBERG	MAURICE SAMPLES
1963	JACKSONVILLE, FLA.	DON TURNER	GORDON WEIR	MAURICE SAMPLES
1964	NASHVILLE, TENN.	BILLY SCOTT	HENRY OAKS	DWAYNE DUKE
1965	BIRMINGHAM, ALA.	BILLY SCOTT	HENRY OAKS	DWAYNE DUKE
1966	ATLANTA, GA.	BILLY SCOTT	HENRY OAKS	DWAYNE DUKE
1967	KNOXVILLE, TENN.	G.TURNER	HENRY OAKS	DWAYNE DUKE
1968	BIRMINGHAM, ALA.	HENRY OAKS	WILLAM PEACE	EDDIE WHITE
1969	NASHVILLE, TENN.	HENRY OAKS	WILLAM PEACE	EDDIE WHITE
1970	DAYONABCH, FLA.	BILLY SCOTT	PALPH OSBORNE	EDDIE WHITE
1971	BIRMINGHAM, ALA.	CARMEN TIBERIO	WILLIAM PEACE	EDDIE WHITE
1972	ATLANTA, GA.	BILLY SCOTT	HOWARD CHAPMAN	EDDIE WHITE
1973	MEMPHIS, TENN.	WILLIAM PEACE	BILLY SCOTT	EDDIE WHITE
1974	BILOXI, MISS.	WILLIAM PEACE	CARMEN TIBERRIO	EDDIE WHITE
1975	KNOVILLE, TENN. @@	WILLIAM PEACE	N/A	EDDIE WHITE
1976	BIRMINGHAM, ALA.	WILLIAM PEACE	N/A	EDDIE WHITE
1977	LOUISVILLE, KY.	WILLIAM PEACE	N/A	ROBERT KOLB
1978	MIAMI, FLA.	EMORY HARRIS	TODD HICKS	ROBERT KOLB
1979	MOBILE, ALA.	EMORY HARRIS	TODD HICKS	ROBERT KOLB
1980	ATLANTA, GA.	EMORY HARRIS	N/A	ROBERT KOLB
1981	BIRMINGHAM, ALA.	EMORY HARRIS	N/A	ROBERT KOLB
1982	LOUISVILLE, KY.	EMORY HARRIS	EDDIE WHITE	ROBERT KOLB
1983	BATON ROUGE, LA.	EMORY HARRIS	EDDIE WHITE	ROBERT KOLB
1984	TAMPLA, FLA.	EDDIE WHITE	ROBERT LORCH	ROBERT KOLB
1985	MOBILE, ALA.	EDDIE WHITE	ROBERT SHEFFIELD	ROBERT LORCH
1986	JACKSONVILLE, FLA.	EDDIE WHITE	ROBERT SHEFFIELD	PHILLIP MICHELL
1987	KNOXVILLE, TENN.	BILLY SCOTT	ROBERT SHEFFIELD	PHILLIP MICHELL
1988	BIRMINGHAM, ALA.	BILLY SCOTT	ROBERT SHEFFIELD	PHILLIP MICHELL
1989	NASHVILLE, TENN.	ROBERT SHEFFIELD	ROBERT SHEFFIELD	PHILLIP MICHELL
1990	WEST PLAM BCH, FLA.	ROBERT SHEFFIELD	ROBERT SHEFFIELD	PHILLIP MICHELL
1991	LOUISVILLE, KY.	ROBERT SHEFFIELD	ROBERT SHEFFIELD	PHILLIP MICHELL
1992	MOBILE, ALA.	ROBERT SHEFFIELD	ROBERT SHEFFIELD	PHILLIP MICHELL
1993	CHATTANOOGA, TENN.	ROBERT SHEFFIELD	ROBERT SHEFFIELD	PHILLIP MICHELL
1994	BATON ROUGE, LA.	ROBERT SHEFFIELD	ROBERT SHEFFIELD	PHILLIP MICHELL
1995	WEST PALM BCH., FLA.	THOMAS DAUGHERTY	ROBERT SHEFFIELD	PHILLIP MICHELL
1996	LOUISVILLE, KY.	THOMAS DAUGHERTY	ROBERT SHEFFIELD	PHILLIP MICHELL
1997	NEW ORLEANS, LA.	THOMAS DAUGHERTY	THOMAS DAUGHERTY	PHILLIP MICHELL
1998	BIRMINGHAM, ALA.	THOMAS DAUGHERTY	THOMAS DAUGHERTY	JAMES HAGGARD
1999	GAITHERSBURG, MD.	THOMAS DAUGHERTY	THOMAS DAUGHERTY	JAMES HAGGARD
2000	ATLANTA, GA.	THOMAS DAUGHERTY	THOMAS DAUGHERTY	JAMES HAGGARD
2001	JACKSONVILLE, FLA.	THOMAS DAUGHERTY	THOMAS DAUGHERTY	JAMES HAGGARD
2002	MOBILE, ALA.	THOMAS DAUGHERTY	THOMAS DAUGHERTY	JAMES HAGGARD
2003	RICHMOND, VA.	THOMAS DAUGHERTY	THOMAS DAUGHERTY	JAMES HAGGARD
2004	GREENSBORO, NC.	THOMAS DAUGHERTY	THOMAS DAUGHERTY	ARKLEY WRIGHT
2005	BOCA RATON, FLA.	THOMAS DAUGHERTY	THOMAS DAUGHERTY	ARKLEY WRIGHT
2006	MONTGOMERY, ALA.	THOMAS DAUGHERTY	THOMAS DAUGHERTY	ARKLEY WRIGHT
2007	CHATTANOOGA, TENN.	TIMOTHY MARTIN	THOMAS DAUGHERTY	ARKLEY WRIGHT
2008	CHARLESTON, WVA.	TIMOTHY MARTIN	TIMOTHY MARTIN	ARKLEY WRIGHT
2009	BATON ROUGE, LA.	TIMOTHY MARTIN	TIMOTHY MARTIN	ARKLEY WRIGHT
2010	BIRMINGHAM, ALA.	HEBRON FORD, JR.	TIMOTHY MARTIN	ARKLEY WRIGHT
2011	RICHMOND, VA.	HEBRON FORD, JR.	TIMOTHY MARTIN	ARKLEY WRIGHT
2012	CHARLOTTE, NC.	HEBRON FORD, JR.	TIMOTHY MARTIN	ARKLEY WRIGHT
2013	JACKSON, MISS	HEBRON FORD, JR.	TIMOTHY MARTIN	ARKLEY WRIGHT
2014	LAFAYETTE, LA.	#### HERRON FORD, JR.	TIMOTHY MARTIN	LAWSON McNALLY
2015	LOUISVILLE, KY.	ROBERT CHAIN, JR.	TIMOTHY MARTIN	LAWSON McNALLY



**Dixie Deaf Bowling Association, May 30<sup>th</sup> Saturday**  
**9:00 a.m**

<b>Team Name</b>	<b>Lane</b>	<b>Team Name</b>	<b>Lane</b>
<b><u>Better Bowlers</u></b> Gerald Byrant Leon Laster David Shaw William Hayse	<b>1</b>	<b><u>Black Water River Deaf Club</u></b> Anothy Cox Raymond Steele, Jr. Wayne Mnich Mike Mnich	<b>2</b>
<b><u>4 Eyeths</u></b> Bill Frohn Kenneth Arnold Thomas O'Shea Billy Ed Melvin	<b>3</b>	<b><u>Charlotte Panthers</u></b> Jerome Brown Donnie Stewart Chadwich Handy Chance Gregory	<b>4</b>
<b><u>Chicago WSAD</u></b> Walter Niesluchowski Michael Mangialardo Edmund Folerzynski Peter Wojcik	<b>5</b>	<b><u>Fightin' Tigers</u></b> Timothy Martin James Parker Robert Garrison Adam Guy	<b>6</b>
<b><u>L.S.B.C. Ind./ KY</u></b> Donald McMonigle Mark Hunt Oscar Hamilton Thomas Smith	<b>7</b>	<b><u>Crimson Tide</u></b> Jeffrey Armstrong David Tamez James Nicholson Robert Wright	<b>8</b>
<b><u>Time to Drinking Beer</u></b> Thomas Daugherty Danny Owens John Wade Jerry Brown	<b>9</b>	<b><u>Fire Balls</u></b> Billy Henderson James Maddox Kevin O'Donnell Robert Chain, Jr.	<b>10</b>
<b><u>Slugger</u></b> Jam O'Hea Andy Donatich James Dudasik Ronnie Zuchegno, Jr.	<b>11</b>	<b><u>FAD'S 2016</u></b> Michael Losh Paul Blahut Leslie Pysell Kevin Scott Rogers	<b>12</b>
<b><u>Strikes/ Spares</u></b> Sammy Collins, Jr Rickey Mayeaux Michael Landry Roger McGartland	<b>13</b>	<b><u>Texas Leftover</u></b> Walter Holder Wilbur Wright Roger Cambron Gerald Goniwicha	<b>14</b>
<b><u>Bowling Addicts</u></b> Jackie Chapman James Bice Richard Wiley Wyatt Wolfe	<b>15</b>	<b><u>Whatever</u></b> David Timms Michael Crowe John McGivney Martin Campbell	<b>16</b>



<b><u>Louisville Silent Bowling Club</u></b> 17		<b><u>Perfect Storm</u></b> 18
Roland Fairfax		Darryl Conner
Hovey Bennett		Greg Gantt
Wayne Pribnow		Steve Burford
Robert Armstrong		Kris Burford
<b><u>L.S.B.C. Ohio</u></b> 19		<b><u>Alabama Gang</u></b> 20
James Marsh		Roy Willcutt
Carlos Acevedo		Lavon Hunter
Darren Barth		Ricky Morgan
Daniel Bays		J. Steven Butt
<b><u>Wolf Packs</u></b> 21		<b><u>Charlotte Hornets</u></b> 22
Louis Buras		Joesph Parisi
George Fraychineaud, Jr.		Craig Brown
Sean Sterling		Godfrey Howard, Jr.
Bryan Stenger		Richard Pinkert
<b><u>Inlanders</u></b> 23		<b><u>Bowling Under Influence</u></b> 24
DJ Powell		Randy Scott, Jr.
Steven Brown		John Ulrich, Sr.
Larry Reedy		Bobby Duncan
Thomas Brown		Marion Bennett, Jr.
<b><u>Balls of Fury</u></b> 25		<b><u>Darker Team</u></b> 26
Johnny McLean		Robert Billingslea
Brice Lowe		Jerry Morris
Richard Hadlock		Bobby Blessing
Reginald Adams		Jeffrey Fife
<b><u>Who Dats!</u></b> 27		<b><u>Feed Me Bowl</u></b> 28
Patrick Davis		Eddie Warscheick
Arthur Porter		Elmo Hickerson
Richard Fraychineaud		Michael Miller
Nicholas Imme		Ken Seabolt
<b><u>Indy 4</u></b> 29		
Bruce Farmer		
Ken Murray		
Lansing Dawley		
Jeff Black		

Single & Double, May 31<sup>st</sup> Sunday  
2 Squad Times at 8:00 a.m. and 12:00 p.m.

Lane/ Names 8:00 a.m.

- 1 - 2 Jerry Morris - Robert Billingslea  
1 - 2 Bobby Blessing - Jeffrey Fife  
1 - 2 Nicholas Imme - Richard Fraychineaud  
3 - 4 Rickey Mayeaux - Sammy Collins, Jr  
3 - 4 Michael Landry - Roger McGartland  
3 - 4 Jackie Chapman - James Bice  
5 - 6 Walter Holder - A. Wilbur Wright  
5 - 6 Richard Wiley - Wyatt Wolfe  
5 - 6 Carlos Acevedo - Darren Barth  
7 - 8 James Marsh - Daniel Bays  
7 - 8 Darryl Conner - Greg Gantt  
7 - 8 Steve Burford - Kris Burford  
9 - 10 Hovey Bennett - Wayne Pribnow  
9 - 10 Bill Frohn - Billy Ed Melvin  
9 - 10 Kenneth Arnold - Thomas O'Shea  
11-12 Godfrey Howard, Jr. - Craig Brown  
11-12 Roy Willcutt - Lavon Hunter  
11-12 Ricky Morgan - J. Steven Butt  
13-14 Louis Buras - George Fraychineaud, Jr.  
13-14 Sean Sterling - Bryan Stenger  
13-14 Joseph Parisi - Richard Pinkert  
15-16 Danny Owens - Jerry Brown  
15-16 Thomas Daugherty - John Wade  
15-16 James Parker - Adam Guy  
17-18 Anthony Cox - Raymond Steele Jr.  
17-18 Wayne Mnich - Mike Mnich  
17-18 William Hayes - David Shaw  
19-20 Billy Henderson - James Maddox  
19-20 Kevin O'Donnell - Robert Chain, Jr.  
19-20 Gerald Bryant - Leon Laster  
21-22 James Dudasik - Ronnie Zuchegno, Jr.  
21-22 Martin Campbell - Michael Crowe  
21-22 Jam O'Hea - Andy Donatich  
23-24 David Timms - John McGivney  
23-24 Paul Blahut - Michael Losh  
23-24 Walter Niesluchowski - Michael Mangialardo  
25-26 Peter Wojcik - Edmund Folerzynski  
25-26 Donnie Stewart - Chance Gregory  
25-26 Jerome Brown - Chadwick Handy  
27-28 Richard Hadlock - Reginald Adams  
27-28 James Nicholson - Robert Wright

Lane/ Names 12:00 p.m.

- 3 - 4 Roger Cambron - Gerald Goniwicha  
3 - 4 Leslie Pysell - Kevin Scott Rogers  
3 - 4 Michael Miller - Ken Seabolt  
5 - 6 Elmo Hickerson - Eddie Warchesick  
5 - 6 Roland Fairfax - Robert Armstrong  
5 - 6 John Ulrich, Sr. - Bobby Duncan  
7 - 8 Larry Reedy - Thomas Brown  
7 - 8 Johnny McLean - Brice Lowe  
7 - 8 Oscar Hamilton - Thomas Smith  
9 - 10 Timothy Martin - Robert Garrison  
9 - 10 DJ Powell - Steven Brown  
9 - 10 Randy Scott, Jr. - Marion Bennett  
11-12 Bruce Farmer - Ken Murray  
11-12 Lansing Dawley - Jeff Black  
11-12 Donald McMonigle - Mark Hunt  
  
29-30 Richard Fraychineaud - Nicholas Imme  
29-30 Arthur Porter - Pat Davis  
29-30 Jeffrey Armstrong - David Tamez



### Prize Lists

	<b>Team</b>	<b>Double</b>	<b>Single</b>	<b>Single 16-29</b>	<b>All- Events</b>	<b>Senior All-</b>
1	\$2000	\$1000	\$500	\$59	\$400	\$200
2	\$1000	\$500	\$250	\$56	\$200	\$120
3	\$500	\$260	\$135	\$53	\$100	\$70
4	\$400	\$230	\$95	\$50	\$80	\$50
5	\$200	\$220	\$92	\$47	\$50	\$20
6	\$140	\$200	\$89	\$44	\$40	
7	\$80	\$180	\$86	\$41	\$30	
8		\$160	\$83	\$38	\$20	
9		\$140	\$80	\$35	\$10	
10		\$120	\$77	\$32		
11		\$100	\$74	\$29		
12		\$80	\$71	\$26		
13		\$60	\$68	\$23		
14		\$40	\$65	\$20		
15			\$62			
<b>\$11380</b>	<b>\$4320</b>	<b>\$3290</b>	<b>\$1827</b>	<b>\$553</b>	<b>\$930</b>	<b>\$460</b>



# HALL OF FAME

YEAR	BOWLING CATEGORY	LEADER CATEGORY
1968	*LEE COLE, GA.	*SAM RITTENBERG, ALA.
1969	*SAM RITTENBERG, ALA.	*HENRY B. OAKS, GA.
1970	*HENRY B. OAKS, GA.	MAURICE SAMPLES, FLA.
1971	LOTT JENNINGS, FLA.	*RUSH LETSON, ALA.
1972	*DOUGLAS HITCHCOCK, GA.	*DON M. TURNER, GA.
1973	*CHARLES ARNOLD, ALA.	*HOWARD CHAPMAN, ALA.
1974	*HOWARD CHAPMAN, ALA.	*CHARLES McNEILLY, JR., FLA.
1975	CANCELLED IN KNOXVILLE, TENN.	
1976	MAURICE SAMPLES, FLA.	*TODD HICKS, FLA.
1977	*TODD HICKS, FLA.	*L.B. ARREN, KY.
1978	*C.B. POLLOCK, FLA.	*DOUGLAS HITCHCOCK, GA.
1979	*W.J. SCOTT, GA.	*W.J. SCOTT, GA.
1980	MACK PADGETT, FLA.	DOUGLAS CUMBIE, FLA.
1981	DOUGLAS CUMBIE, FLA.	DUWAYNE DUKES, GA.
1982	EDWARD C. CARNEY, FLA.	CARMEN S. TIBERIO, FLA.
1983	RAY HIPPI, SR., ALA.	*WILLIAM PEACE, FLA.
1984	JOHN ETHRIDGE, GA.	*CARL G. TURNER, GA.
1985	*ROBERT LORCH, GA.	BILLY JOE SCOTT, JR., ALA.
1986	ADDIN LIGHTBODY, FLA.	*H.E. HARTSFIELD, GA.
1987	BONNIE CRAIG, GA.	*ROBERT LORCH, GA.
1988	MERLIN TICE, FLA.	*WINFORD SIMMONS, KY.
1989	*CHARLES "BUD" LITTLE, GA.	NO SELECTION
1990	HEBERT DANNIS, FLA.	NO SELECTION
1991	*CARL G. TURNER, GA.	NO SELECTION
1992	WILLIAM N. GULLEY, SR., KY.	NO SELECTION
1993	*WILLIAM PEACE, NC.	NO SELECTION
1994	*DALE WHITE, GA.	NO SELECTION
1995	JOHN NELSON, FLA.	DARWIN HOLMES, FLA.
1996	ROBERT KOLB, KY.	ROBERT KOLB, KY.
1997	BILLY JOE SCOTT, SR., ALA.	NO SELECTION
1998	CHARLES STRINGER, ALA.	*PHILLIP MITCHELL, ALA.
1999	NO SELECTION	JAMES EDDIE WHITE, ALA.
2000	JACK CARBONELL, FLA.	*ROBERT SHEFFIELD, SC.
2001	NO SELECTION	NO SELECTION
2002	JAMES BICE, ALA.	*JAMES HAGGARD, ALA.
2003	JAMES BUEMI, MD.	NO SELECTION
2004	*GEORGE RANDOLPH, FLA.	*ARTHUR HARGIS, TENN.
2005 - 2006	NO SELECTION	
2007	WILLIAM DUCAN, VA	
2008	JAMES ENNIS, WVA.	
2009	TIMOTHY MARTIN, LA. & EVERETT BLAKENEY, LA.	
2010	STEVE BUTT, ALA. & TOM DAUGHERTY, ALA.	
2011	ROLAND FAIRFAX, KY.	
2012	NO SELECTION	
2013	*HEBRON FORD, JR., ALA. & JERRY TUSSING, VA.	
2014		

\* DECEASED

**PAST RECORDS  
TEAM EVENTS  
FOUR- MEN TEAM EVENT**

YEAR	HANDICAP	SCORE
1977	THE FOURACES, KY.	2438
1978	NATION'S CAPITOL DEAF CLUB, GA.	2345
1979	BULLS, TENN.	2322
1980	ATLANTA CLUB NO. 1, GA.	2469
1981	NORTHEAST FLA. ALL-STARS, FLA.	2361
1982	ORANGE CRUSH, FLA.	2445
1983	DICKSON PRO SHOP, MD. / VA. / ALA.	2479
1984	BIG FOUR, TEXAS	2461
1985	LAST MINUTE, TEXAS	2360
1986	SOUTHERN REBEL, GA.	2473
1987	MOBILE ASSN. DEAF #2 ALA.	2450
1988	NWEAD, FLA.	2509
1989	LOUISIANA, LA.	2350
1990	NASTY BOYS, FLA.	2403
1991	STARS OF RICHMOND, VA.	2439
1992	FIGHTING TIGERS, LA.	2376
1993	NASHVILLE CLUB DEAF, TENN.	2463
1994	LOUISVILLE SILENT BOWLING CLUB, KY.	2507
1995	MARYLAND ALUMNI, MD.	2608
1996	LOUISVILLE SILENT BOWLING CLUB, KY.	2611
1997	MOBILE ASSN. DEAF, ALA.	2541
1998	MOBILE ASSN. DEAF, ALA.	2656
1999	MOBILE ASSN. DEAF, ALA.	2656
2000	ATLANTA DBA., GA	2516
2001	FLYING TIGERS, LA./WVA./ALA.	2644
2002	HOOSIERS, IND.	2722
2003	TRI- STATE BOWLERS, NY.	2652
2004	SHUT UP AND BOWL, NY.	2698
2005	LaFAMILIA, NY.	2784**
2006	GEORGIA DEAF BOWL, GA.	2678
2007	GBAD SALT/PEPPER, ALA.	2730
2008	STORM WARNING NY/ OH.	2667
2009	FADS 2008, WVA./ MD.	2703
2010	4 EYETHS, MD. / VA.	2637
2011	LOUISVILLE SILENT BOWLING CLUB, KY.	2575
2012	CAROLINA PANTHERS, NC.	2502
2013	FIGHTING TIGERS, LA.	2677
2014	ALABAMA GANG	2481

**PART RECORDS  
TEAM EVENTS  
FIVE - MEN TEAM EVENT**

YEAR	HANDICAP	SCORE
1951	ATLANTA CLUB "A" GA.	2733
1952	BIRMINGHAM SILENT, ALA.	2811
1953	BIRMINGHAM SILENT, ALA.	2816
1954	HIALEAH SHOE REPAIR, FLA.	2924
1955	ATLANTA DEAF KEGLERS, GA.	2740
1956	BIRMINGHAM SILENT, ALA.	2868
1957	LOUISVILLE ASSN. OF DEAF, KY.	2939
1958	ATLANTA DEAF KEGLERS, GA.	2819
1959	SOUTH FLORIDA STARS, FLA.	2841
1960	SOUTH FLA. GOLD COASTERS, FLA.	2829
1961	BIRMINGHAM CLUB OF DEAF, ALA.	2852
1962	ATLANTA NFSD NO. 2, GA.	2873
1963	WEIR LUMBER CO., MISS.	2925
1964	MEMPHIS CLUB DEAF, TENN.	2831
1965	MAGIC CITY, FLA.	3021
1966	FLORIDA STARS, FLA.	2954
1967	FALCONER, ALA.	3012
1968	ATLANTA ATHLETIC CLUB, GA.	3180**
1969	GREATER LOUISVILLE DEAF CLUB, KY.	2950
1970	COLUMBIA ACE, SC.	2985
1971	HERB-HARRY'S UNION 76, ALA.	2899
1972	KNOXVILLE A.A. DEAF, TENN.	2970
1973	KRAEMER'S KEGLERS, LA.	2927
1974	BIRMINGHAM ATHLETIC DEAF, ALA.	2889
1975	CANCELLED DUE IN KNOXVILLE, TENN.	
1976	NO DATE	



**PART RECORDS  
SINGLE EVENTS  
THREE GAMES**

SCORE

YEAR	HANDICAP	SCORE
1951	HERBERT DANNIS, ALA.	670
1952	DON TURNER, GA.	635
1953	JAMES PRITCHARD, FLA.	612
1954	M.O. CHANDLER, FLA.	649
1955	L. ZIMET, FLA.	644
1956	CHARLES ARNOLD, ALA.	701
1957	K. BENZEL, KY.	682
1958	DOUGLAS CUMBLE, FLA.	681
1959	LOTT JENNIGS, FLA.	600
1960	HOWARD CHAPMAN, ALA.	587
1961	HERBERT DENNIS, GA.	608
1962	JOHN ETHRIDGE, GA.	585
1963	DALE WHITE, GA.	619
1964	FLOYD MELONE, TENN.	654
1965	BOBBY BISHOP, ALA.	682
1966	JAMES WHITE, ALA.	683
1967	WILBURN ARTIS, ALA.	639
1968	EMORY HARRIS, ALA.	647
1969	RALPH HIPPS, ALA.	589
1970	CHARLES MULLINS, TENN.	680
1971	MIKE VITTHOW, KY.	679
1972	EARL LANGLEY, FLA.	687
1973	CHARLES LYONS, GA.	648
1974	NO DATA	
1975	CANCELLED IN KNOXVILLE, TENN.	
1976	NO DATA	673
1977	HARRY STORM, ILL.	680
1978	ALVIN PIERCE, LA.	712
1979	MIKE ROBERTSON, TENN.	
1997	BUDDY BLAKENEY, LA.	709
1999	KEITH SIEGEL, FLA.	741
2000	TIMOTHY MARTIN, LA.	737
2001	DAVID REEVES, IND.	721
2002	JOE ED THOMPSON, TEX.	750
2003	ROBERT GARRISON, OH.	752
2004	JAMES WILSON, LA.	749
2005	ROY WILCUTT, ALA.	750
2006	CHRISTOPHER SHIELDS, KY.	760
2007	RAYMOND DUFFEY, GA.	775 **
2008	ROGER LIVINGTON, NC.	768
2009	MIKE LANDRY, LA.	750
2010	DENNIS POUNDS, LA.	766
2011	KENNETH TULLIS, MD.	735
2012	BOBBY FULLER, MD.	721
2013	LOUIS BURAS, LA.	734
2014	J. STEVE BUTT, LA.	682

ROBERT GARRISON, LA. 681  
 K. SIEGEL/ J. VIRGADALLA, FLA. 683  
 JAMES BUEML, MD. 676  
 DAVIS REEVES, IND. 721  
 JOE ED THOMPSON, TEX. 740  
 ROBERT GARRISON, OH. 719  
 KRIS BOFORD, OH. 648  
 JAMES MORRIS, MD. 741 \*\*  
 TERRELL GARRETT, TENN. 677  
 JERRY K. BROWN, VA. 720  
 BOBBY FULLER, MD. 708  
 DOUGLAS HALEY, TEX. 694  
 KRIS BUFOORD, OH. 697  
 JERRY BROWN, VA. 683  
 DOUGLAS HALEY, TEX. 696  
 DOUGLAS HALEY, TEX. 674  
 BILLY ED MELVIN, MD. 674

**PAST RECORDS  
TEAM EVENTS  
FOUR-MEN TEAM**

SCORE

YEAR	SCRATCH	SCORE
1977 - 1987	NO DATA	
1988	LOUISVILLE CARDINAL #1, KY.	2185
1989	LIITIE ROCKERS, AKR.	2185
1990	NO DATA	
1991	STARS OF RICHMOND, VA.	2235
1992	FIGHTING TIGERS, LA.	2046
1993	LRDBA-WILD HOGS, AKR.	2111
1994	LOUISVILLE SILENT BOWLING CLUB	2228
1995	THE FLORIDIANS, FLA.	2431
1996	LOUISVILLE SILENT BOWLING CLUB	2413
1997	FIGHTING TIGERS, LA.	2387
1998	MOBILE ASSN. DEAF, ALA.	2209
1999	PNC PARK, PA.	2422
2000	LAST MINUTE PRO, MICH.	2439
2001	BOLD EAGLES, MICH.	2455
2002	HOOSIER, IND.	2581
2003	PREDATORS, OH.	2509
2004	SHUT UP AND BOWL, NY.	2629 **
2005	LaFAMILLIA, NY.	2595
2006	GEORGIA DEAF BOWL, GA.	2369
2007	PIN CRUSH, IND.	2606
2008	STORM WARNING, NY.	2628
2009	D/STRIKERS TEXAS/ IND.	2369
2010	GUTTER GUARDS, CAN./ILL./NY./OH.	2428
2011	GOT STRIKES, IND.	2564
2012	THE FANTASTIC #4, NY.	2271
2013	JACKSON BOWLER DEAF, MISS.	2384
2014	PERFECT STROM, IND.	2272

# PAST RECORDS SINGLE EVENTS

## FIVE GAMES

YEAR	HANDICAP	SCORE	SCRATCH	SCORE
1980	JOHN DEHOTEL, LA.	1085		
1981	MIKE GRIFFIN, KY.	1088		
1982	C. PODGOMISK, NY.	1150		
1983	BRUCE CLARY, TEX.	1117		
1984	BILL HAYES, TENN.	1077		
1985	EVERETT BLAKENEY, LA.	1075		
1986	JIMMY BOWEN, TENN.	1084		
1987	JIM FOGLESONG, VA.	1133		
1988	ROLAND FAIREAX, KY.	1132		
1989	STEVE HENDRIX, FLA.	1139		
1990	BILL R. FOX, JR., FLA.	1051		
1991	DAVID S. HERBOLD, VA.	1109		
1992	EDDIE TURNER, GA.	1110		
1993	IRA V. TROOP, GA.	1180		
1994	JERRY TUCKER, ALA.	1105		
1995	JIM STOCKARD, TENN.	1172		
1996	JAMES D. CLAUCHEEY, WVA.	1175 **		
1998	JERRY TUCKER, ALA.	1099		
	BILL HAYES, ALA.	1016		
	PHIL CRUS, MICH.	1001		
	RUSSELL STEIN, FLA.	1040		
	JAMES WHITE, ALA.	973		
	BILL HAYES, ALA.	1154		
	ROBERT GARRISON, LA.	1022		
	GERALD BUCKINGHAM, PA.	1075		
	BILL HAYSE, TENN.	1133		
	JAMES MORRIS, MD.	972		

# PAST RECORDS

## ALL EVENTS

## EIGHT GAMES

YEAR	HANDICAP	SCORE	SCRATCH	SCORE
1980 - 1981	NO DATA			
1982	C. PODGOMISK, NY.	1774		
1983	BRUCE CLARY, TEX.	1740		
1984	G. BUCKINGHAM, NY.	1735		
1985	CHARLES STRINGER, ALA.	1677		
1986	FRED FRISBEE, GA.	1690		
1987	JIMMY CAPPS, KY.	1730		
1988	ROLAND FAIREAX, KY.	1851 **		
1989	PHILIP MICHELL, ALA.	1665		
1990	LEONARD AMATO, NY.	1677		
1991	ROBERT LEE SMITH, WV.	1731		
1992	EUGENE LOCKARD, KY.	1688		
1993	BILL HAYES, ALA.	1785		
1994	JERRY TUCKER, ALA.	1740		
1995	JIMMIE JOHNSON, NC.	1794		
1996	BILL HAYES, ALA.	1836		
1998	JERRY TUCKER, ALA.	1667		

# ROBERT KORB MASTER

YEAR	CHAMPIONSHIP	SCRATCH	RUNNER UP
1983	TIMOTHY MARTIN, LA.		ROBERT LORCH, GA.
1984 - 1988	NO DATA		NO DATA
1989	JACKIE FREDERICK, ALA.		NO DATA
1990	BILL DAVIS, ILL.		NO DATA
1991	DANIEL KRAPALA JR., VA.		ROLAND FAIREAX, KY.
1992	DANIEL KRAPALA JR., VA.		WYATT WOLFE, ALA.
1993	RANDY PERT JR., FLA.		BILL HAYSE, ALA.
1994	BERNARD NEDDLEMAN, FLA.		ROLAND FAIREAX, KY.
1995	FRANK KREINER,		RUSSEL STEIN, FLA.
1996	BILL HAYSE, TENN.		JAMES BUEMLI, MD.
1997	DAVID REEVES, IND.		TOM DAUGHERTY, ALA.

## HANDICAP

1998	DANNY FINE, FLA.		
1999	RICKY MORGAN, ALA.		JAMES BUEMLI, MD.
2000			
2001			
2002	JERRY PRINZLER		TOM DAUGHERTY, ALA.
2003			
2004			
2005			
2006	TOM DAUGHERTY, ALA.		TRAVIS MATHIS,
2007	TIMOTHY MARTIN, LA.		DAVID E. BUCNER JR.,
2008	CHRISTOPHER HEATH, NC.		TIMOTHY MARTIN, LA.
2009	HENRY SIARKOWSKI, JR., MD.		WYATT WOLFE, ALA.
2010	RAI DOBMEIER, RI.		LOREN FRYE, NC.
2011	JERRY BROWN, VA.		TERRANCE WRIGHT, GA.
2012	BOBBY CUMBEST, ALA.		JAMIE O' HEA, NY.
2013	ROBERT CHAIN, JR., MISS.		CHANCE GREGORY, NC
2014	KRIS BURFORD, IND.		BERNARD ZUFALL, TX

# JOHN ETHRIDGE SENIOR CITIZEN

## HANDICAP

YEAR	CHAMPIONSHIP	RUNNER UP
2000	HAROLD LEIKER	J. MILLER
2001		
2002		
2003		
2004	TOM DAUGHERTY, ALA.	WAYNE BERKE,
2005		
2006	GERALD GONIWICHIA, MICH.	WILLIAM DUNCAN, VA.
2007	HEBRON FORD JR., ALA.	JIMMY BOWEN, TENN.
2008	JAMES BICE, ALA.	EDWARD JOHNSON, ALA.
2009	WYATT WOLFE, ALA.	GERALD GONIWICHIA, MI
2010	ROBERT BILLINGSLEA,	HAROLD LEIKER, KS.
2011	BILLY ED MELVIN, MD.	WILLIAM FROHN, VA.
2012	BILLY ED MELVIN, MD.	THOMAS O' SHEA, MD.
2013	WYATT WOLFE, LA.	HAROLD STUART, ALA
2014	KEVIN O' DONNELL, NY	J. STEVE BUTT, ALA



PAST RECORDS  
DOUBLE EVENTS  
HANDICAP

YEAR	DOUBLES	SCORE
1951	C. POLLOCK / M. SAMPLES, FLA.	1245
1952	D. TURNER / M. PADGETT, GA.	1189
1953	H. OAKS / W.J. SCOTT, GA.	1189
1954	H. OAKS / W.J. SCOTT, GA.	1261
1955	G. HERBS / J. PORTERSCHLELLER, FLA.	1218
1956	L. GARNER / J. ETHERIDGE, GA.	1260
1957	H. TINCHEP, FLA. / G. CUMMINGS, TENN.	1273
1958	J. VICKERS, FLA. / H. HERROD, KY.	
1959	NO DATA	
1960	D. STEPHENS / H. CHAPMAN, ALA.	1230
1961	M. SAMPLES / A. LIGHTBODY, FLA.	1194
1962	J. BRODRIQUE / R. OSBORNE, TENN.	1150
1963	M. TICKS / W. PEACE, FLA.	1152
1964	J. NELSON / M. SAMPLES, FLA.	1233
1965	H. OAKS / DALE WHITE, GA.	1254
1966	J. WHITE / D. CHAPMAN, ALA.	1198
1967	J. WHITE / D. CHAPMAN, ALA.	1360
1968	C. TIBERIO / W. ST JOHN, FLA.	1251
1969	T. ZAREMBA / W. SHERWOOD, MD.	1233
1970	J. GARDNER / L. ANDERSON, FLA.	1249
1971	S. RITTENDER, ALA. / J. BRADLEY, GA.	1274
1972	D. HUGES, TENN. / R. HOIT, GA.	1227
1973	L. BAIN / B. HANKET, LA.	1221
1974	NO DATA	
1975	CANCELLED IN KNOXVILLE, TENN.	
1976-1996	(1998) NO DATA	
1997	CAWE / THWEART, GA.	1346
1999	A. TALBERT / R. PRAZIOSO, MD.	1416
2000	J. TUCKER / B. OSBORNE, ALA.	1351
2001	J. TUSSING / J. WOLFE, VA.	1368
2002	A. KOVCAS / H. SMITH, MICH.	1410
2003	C. TURNER / D. REED, SC.	1443
2004	R. WINZE RAID / M. CAMPBELL, GA.	1399
2005	M. CROW / S. COLLINS, GA.	1447
2006	B. CUMBEST, LA. / R. GRAVES, ALA.	1399
2007	J. WESTMORELAND / S. WILLIAMSON, MISS.	1284
2008	D. KRPAIA / K. BLANKS, MD.	1449
2009	R. WRIGHT, ALA. / J. HOLLIS, NY.	1442
2010	J. KELMAN / B. J. MELVIN, MD.	1501**
2011	R. FRAYCHINEAUD, LA. / S. KEY	1431
2012	T. PARKER, IND. / J. O'HEA, NY.	1225
2013	D. HALEY / J. DALTON, TEX.	1490
2014	R. WILLCUT / J. STEVE BUTT, ALA.	1269

YEAR	DOUBLES	SCORE
1951 - 2003	NO DATA	
2004	D. REEVES / D.J. POWELL, IND.	1260
2005	NO DATA	
2006	M. CROWE / S. COLLINS, JR., GA.	1298
2007	G. TRAYNER, CAN. / N. LoGRECO MICH.	1389
2008	D. KRPAIA / K. BLANKS, MD.	1361
2009	R. SCOTT, SR. MD. / G. HALAS, CAN.	1411
2010	J. KELMAN / B. J. MELVIN, MD.	1237
2011	A. JOHNSON JR. / S. COLLINS, GA.	1354
2012	T. PARKER, IND. / J. O'HEA, NY.	1418**
2013	D. HALEY / J. DALTON, TEX.	
2014	M. TRIPLETT / B. NAQUYEN,	1169

PAST RECORDS  
DOUBLE EVENTS  
SCRATCH



# **Metro**

## **PROMOTIONAL SERVICES**

**T-shirts-Sweats-Caps**

**Silk Screening-Embroidery-Awards/Trophies**

**Promotional Products-Banners & Signs**

**4333 Taylor Blvd.**

**Louisville, Ky. 40215**

**Bus. 502-368-9391**

**Fax: 502-368-4102**

**[www.metropromotionalservices.com](http://www.metropromotionalservices.com)**

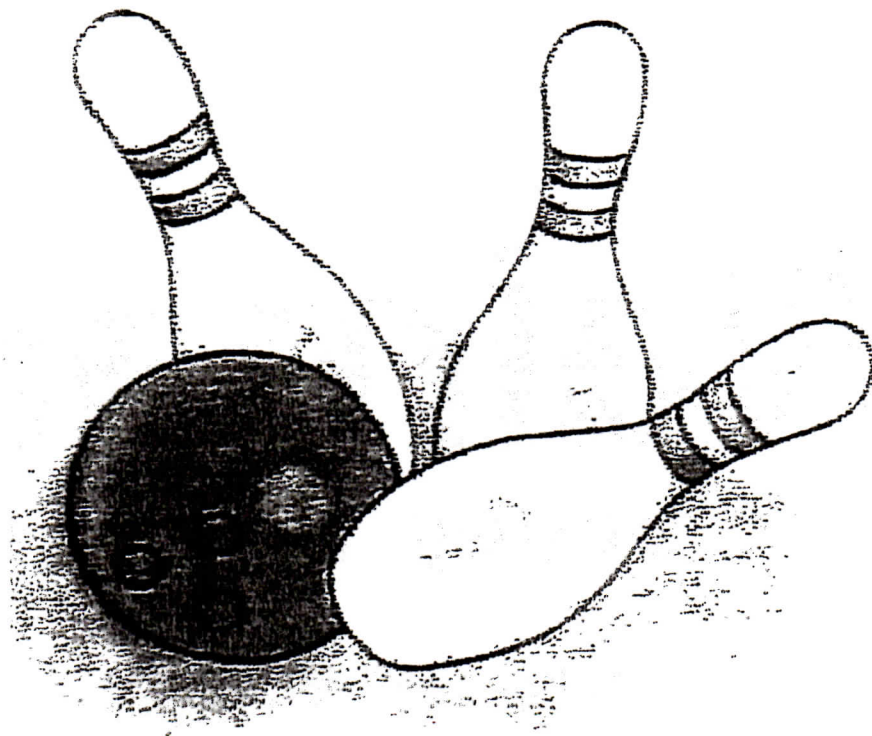



**65th MEN'S AND 48th WOMEN'S  
DIXIE DEAF BOWLING ASSOCIATION**

**GOOD LUCK & BEST WISHES TO ALL BOWLERS**

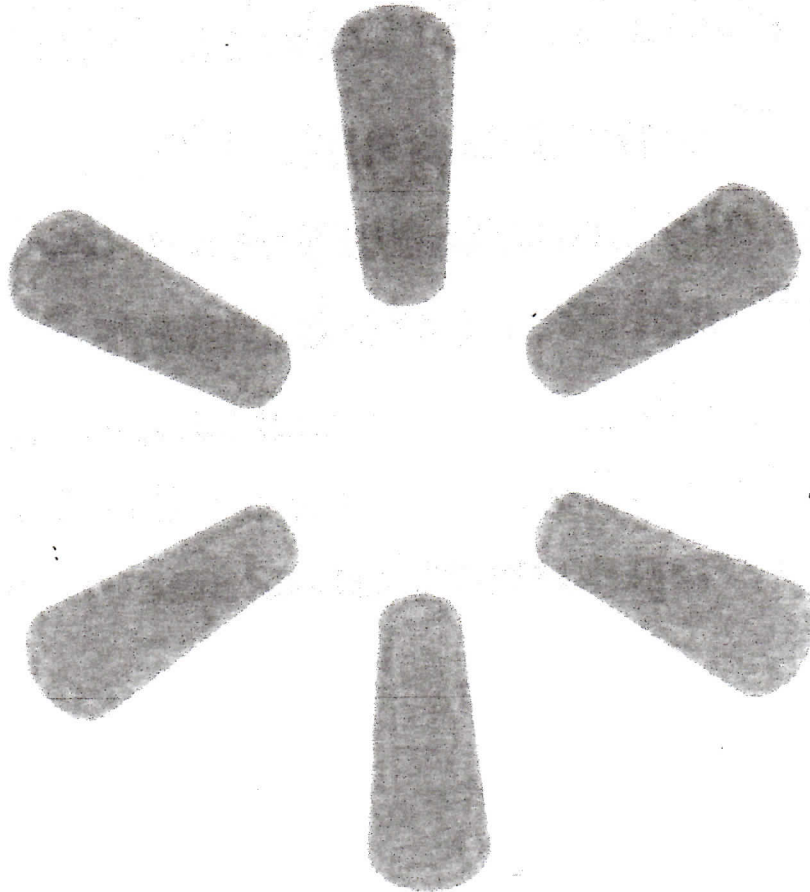

**Walmart**

**Save money. Live better.**

**LOUISVILLE SILENT BOWLING CLUB  
WANT TO THANK  
WALMART**



# KINGPIN LANES

Welcome Dixie Deaf Bowling Tournament

WOULD LIKE YOU TO EXPERIENCE LOUISVILLE'S  
NEWEST BOWLING AND ENTERTAINMENT FACILITY

50 TOURNAMENT-QUALITY LANES  
4 "SMALL BALL" LANES FOR ALL AGES  
X-TREME™ BOWLING AVAILABLE FOR PRIVATE FUNCTIONS  
STATE-OF-THE-ART ARCADE WITH PRIZE REDEMPTION  
FULL-SERVICE CAFE, LOUNGE AND KARAOKE BAR

Roll WITH THE King!

Arcade

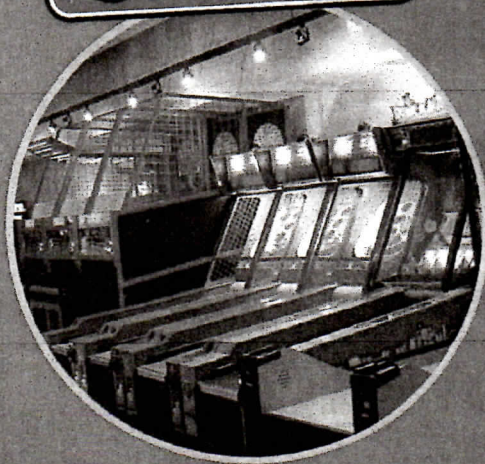

Cafe

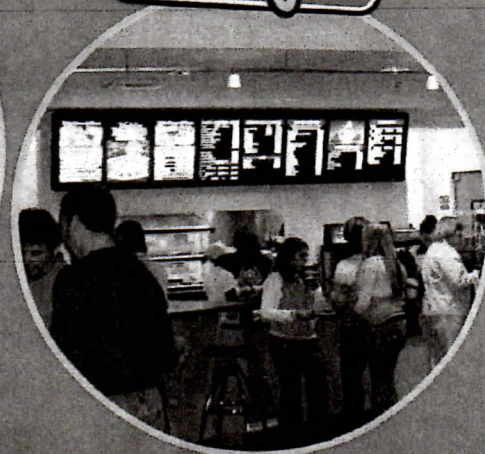

Lounge

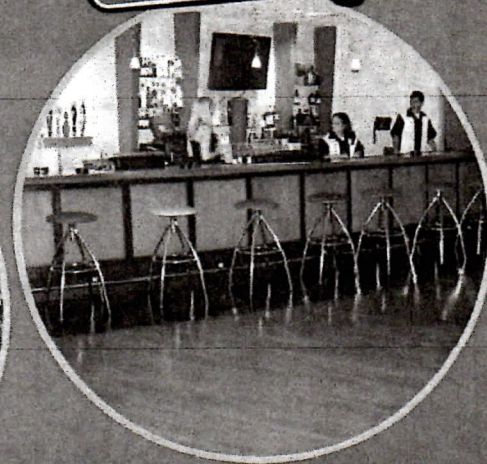

502.719.5464  
[WWW.BOWLKINGPIN.COM](http://WWW.BOWLKINGPIN.COM)

9525 TAYLORSVILLE RD  
JEFFERSONTOWN, KY 40299  
(ONE MILE EAST OF HURSTBOURNE LANE)







# Dixie Deaf Bowling Association

**Good Luck &  
Best Wishes to  
all bowlers!**

*Blake Noland*

*Ok Zulauf*

*Rachel  
Mayer*

*Jessica  
Cullen  
Smith*

*EMILY  
KIMBLE*

*Janice  
Loud*

*Jim R...  
R...  
R...*

*Jashira  
Covey*

*Raena Holloway*

*Nashua  
May*

*Kijana*

*Rachel  
Rogers*

# KCDHH

*William  
Wright*

Kentucky Commission on the Deaf and Hard of Hearing

502-573-2604 (v/tty) - [KCDHH@kcdhh.ky.gov](mailto:KCDHH@kcdhh.ky.gov)



Louisville Silent Bowling Club

Wishes Special Thanks

To

**Kentucky Commission for the Deaf and Hard of Hearing**

For their Sponsorship of \$200

Toward this Successful

Tournament

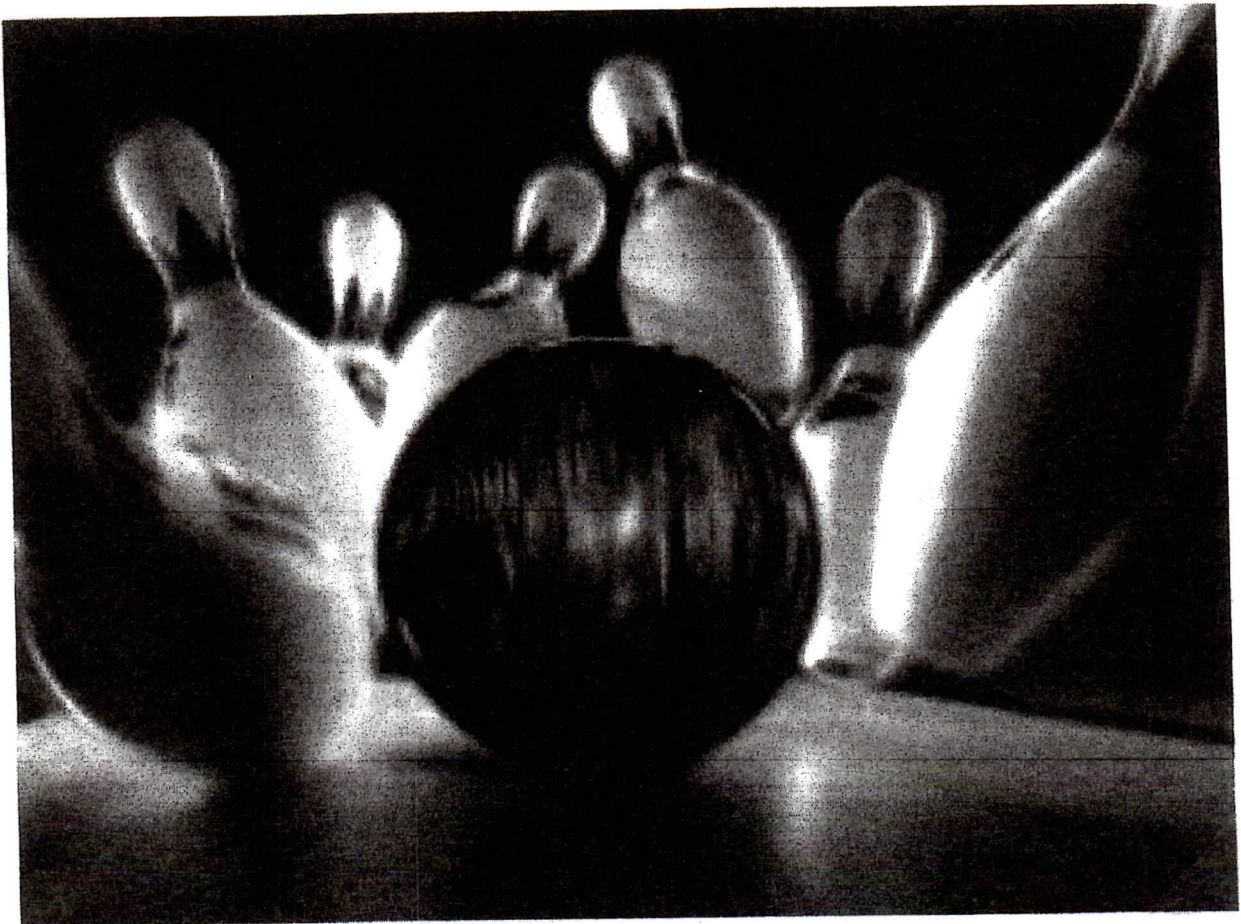



30th ANNUAL

# KENTUCKY MIXED TAP 9

INDIVIDUAL HANDICAP BOWLING TOURNAMENT  
OPEN TO DEAF AND HARD HEARING BOWLERS  
3 GAMES ACROSS 6 LANES

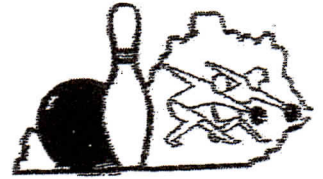
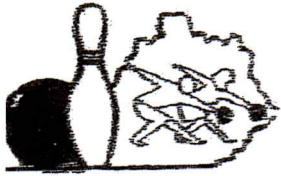

## SATURDAY AUGUST 15, 2015

START 1:00 P.M. GAMES

### GALAXY BOWLING CENTER

1025 AMBERLY WAY  
RICHMOND, KY.  
32 LANES

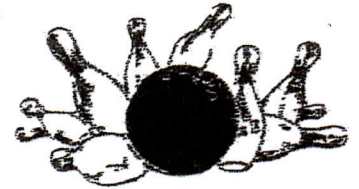

#### ENTRY FEES

PRIZES .....\$16.00  
BOWLING .....\$ 6.00  
EXPENSE .....\$3.00

## \$25.00

AT BOWLING DOORS  
FANS & BOWLERS

## FREE

#### NON - SANCTIONED

MIXED  
80% HANDICAP FROM 210  
70 PINS MAXIMUM  
PER GAME LIMIT

PRIZE RETURNED 100%  
PRIZE RATIO 1 / 1

#### 1st PLACE

#### PRIZES MONEY

BASED ON 25 ENTRIES  
1st PL. TO 25th PLACE

8 TOP QUALIFIERS  
DOUBLE ELIMINATION  
START 2:30 P.M.

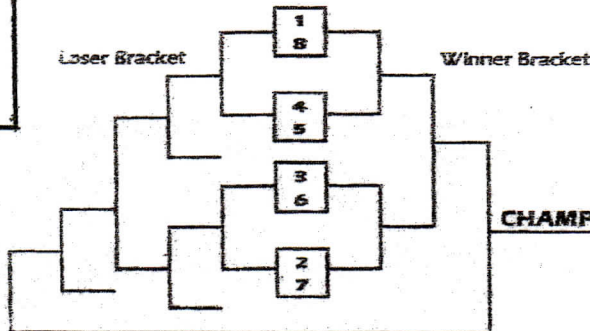

ALL BOWLERS USE THEIR HIGHEST BOOK AVERAGE 2014 - 2015;  
IF NONE OF THE ABOVE USE HIGHEST CURRENT AVERAGE MINIMUM  
OF 21 GAMES THIS SUMMER. ALL OTHER ENTERING AVERAGE WILL  
ESTABLISH AN AVERAGE FOR FIRST SERIES EACH OF BOWLING  
FOR THE PURPOSE OF A HANDICAP.

### ENTRY BLANK BOTH MEN AND WOMEN

NAME \_\_\_\_\_ AVERAGE 2015 \_\_\_\_\_

ADDRESS \_\_\_\_\_

TOWN \_\_\_\_\_ STATE \_\_\_\_\_ ZIP \_\_\_\_\_

PAST RECORDS  
ALL EVENTS  
NINE GAMES

YEAR	HANDICAP	SCORE	SCRATCH	SCORE
1951	HERBERT DENNIS, ALA.	1772		
1952	DON TURNER, GA.	1772		
1953	W. CASHMORE, FLA.	1776		
1954	M. O. CHANDLER, FLA.	1783		
1955	MACK PADGETT, GA.	1761		
1956	CHARLES ARNOLD, ALA.	1811		
1957	G. KESSLER, IND.	1794		
1958	J. VICKERS, FLA.	1830		
1959	LOTT JENNINGS, FLA.	1805		
1960	HOWARD CHAPMAN, ALA.	1796		
1961	HOWARD CHAPMAN, ALA.	1772		
1962	JOHN ETHRIDGE, GA.	1751		
1963	FRANK LaROSS, ALA.	1852		
1964	STANLEY HICKS, TENN.	1768		
1965	WADE ANDERSON, TENN.	1886		
1966	JAMES WHITE, ALA.	1811		
1967	WWILBUR ARTIS, ALA.	1970		
1968	LEON BOWMAN, ALA.	1966		
1969	JOHN FORD, ALA.	1859		
1970	ROBERT ATHOMASON, FLA.	1915		
1971	MIKE VITTLow, KY.	1906		
1972	EARL LANGLEY, FLA.	1922		
1973	JAMES HICKS, ARK.	1941		
1974	J. WHITE & E. PENNINGTON, ALA.	1976		
1975	CANCELLED IN KNOXVILLE, TENN.			
1976	NO DATA			
1977	D. CROFT, MICH.	1952		
1978	MICHAEL TICE, FLA.	1883		
1979	CHARLES ARNOLD, ALA.	1890		
1980- 1996	NO DATA			
1997	RUDDY BLAKENEY, LA.	2083		
1998	NO DATA			
1999	ALLEN TALBERT, MD.	2113		
2000	JERRY BROWN, VA.	2115		
2001	ARKEY WRIGHT, WVA.	2051		
2002	ROBERT FITZGERALD, ALA.	2170		
2003	JEFFREY MacGIFREY, FLA.	2092		
2004	JAMES BROWN, VA.	2146		
2005	A. BROOKS, KY	2110		
2006	TERRELL GARRETT, TENN.	2159		
2007	DAVID SIPPLE, VA.	2026		
2008	ROLAND FAIRFAX, KY.	2098		
2009	ROBERT RYAN, TEX.	2137		
2010	AUTHUR PORTER, ALA.	2173**		
2011	R. FRAYCHINEAUD, LA.	2142		
2012	MARION BENNETT, JR., MA.	2068		
2013	ROBERT CHAIN, JR., MISS.	2153		
2014	BERNARD ZUFALL, TEXAS	1967		

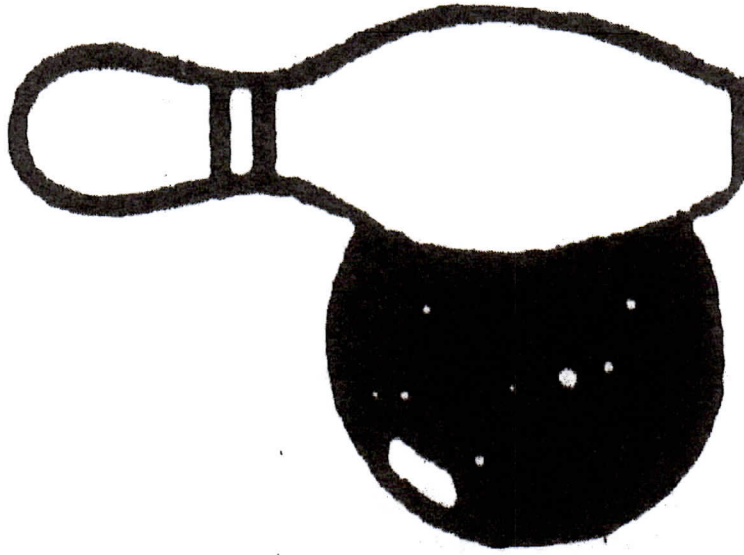



## *Dixie Deaf Women's Bowling Association*

---

*Hello All Fans, Bowlers and Officers:*

*It is my exciting pleasure to welcome each of you to the our 48<sup>th</sup> DDWBA bowling tournament in Louisville, Kentucky.*

*The Belle of Louisville is the oldest operating Mississippi-style sternwheeler steamboat in existence. She is 100 years old as of 2014!*

*We know some famous Louisvillians by names: Diane Sawyer, Tom Cruise, Abraham Lincoln, Thomas A. Edison, Zachary Taylor and others.*

*I would like to extend my sincere thanks to Roland Fairfax and his outstanding committee for working hard to make this tournament become a reality for us. Hands wave to them.*

*May each of you have a wondrous time at this tournament and etch memories to remember.*

*May you all travel home safely Sunday and come back again in West Virginia in May 2016.*

*Go striking down the lanes!*

*Patricia Henderson  
DDWBA Secretary-Treasurer*

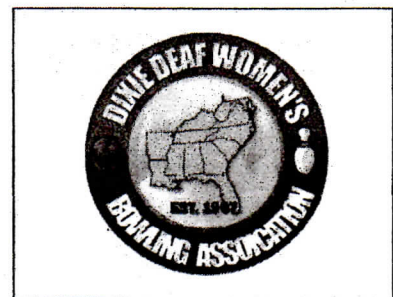

2015

# 48th Annual Dixie Deaf Women Bowling Association

## Unofficial Distribution of Prizes

<u>Entries</u>	<u>*Host city</u>	<u>Prizes</u>	<u>Lane Fees</u>	<u>Expense</u>	<u>2017</u>	<u>Total</u>
				<u>Fees</u>	<u>Fundraising</u>	
Teams	\$ 740.00	\$ 1,040.00	\$ 572.00	\$ 156.00	\$ 104.00	\$ 2,612.00
Doubles	\$ 370.00	\$ 1,040.00	\$ 572.00	\$ 156.00	\$ 104.00	\$ 2,242.00
Singles	\$ 190.00	\$ 1,040.00	\$ 572.00	\$ 156.00	\$ 104.00	\$ 2,062.00
Hipp Queens	\$ 180.00	\$ 360.00	\$ 360.00	\$ 90.00	\$ -	\$ 990.00
Senior Queens	\$ -	\$ 200.00	\$ 200.00	\$ 50.00	\$ -	\$ 450.00
All Events	\$ -	\$ 175.00	\$ -	\$ -	\$ -	\$ 175.00
Senior Citizens All Events	\$ -	\$ 39.00	\$ -	\$ -	\$ -	\$ 39.00
<b>Total</b>	<b>\$1,480.00</b>	<b>\$ 3,894.00</b>	<b>\$ 2,276.00</b>	<b>\$ 608.00</b>	<b>\$ 312.00</b>	<b>\$ 8,570.00</b>

\*Louisville Silent Bowling Club

**13 Teams**

\$740.00 Donated by Host + \$1040.00= \$1780.00

1st Place	\$ 1,000.00
2nd Place	\$ 500.00
3rd Place	\$ 280.00
<b>Total</b>	<b>\$ 1,780.00</b>

**26 Doubles**

\$370.00 Donated by Host + \$1040.00= \$1410.00

1st Place	\$ 500.00
2nd Place	\$ 250.00
3rd Place	\$ 200.00
4th Place	\$ 180.00
5th Place	\$ 160.00
6th Place	\$ 120.00
<b>Total</b>	<b>\$ 1,410.00</b>

**52 Singles**

\$190.00 Donated by Host + \$1040.00= \$1230.00

1st Place	\$ 250.00
2nd Place	\$ 180.00
3rd Place	\$ 130.00
4th Place	\$ 110.00
5th Place	\$ 95.00
6th Place	\$ 80.00
7th Place	\$ 70.00
8th Place	\$ 65.00
9th Place	\$ 60.00
10th Place	\$ 55.00
11th Place	\$ 50.00
12th Place	\$ 45.00
13th Place	\$ 40.00
<b>Total</b>	<b>\$ 1,230.00</b>

**18 Hipp Queen**

\$180.00 Donated by Host  
+ \$360.00 = \$540.00

1st Place	\$ 200.00
2nd Place	\$ 105.00
3rd Place	\$ 80.00
4th Place	\$ 55.00
5th Place	\$ 25.00
6th Place	\$ 25.00
7th Place	\$ 25.00
8th Place	\$ 25.00
<b>Total</b>	<b>\$ 540.00</b>

**10 Senior Queen**

\$200.00 + \$33.00=\$233.00

1st Place	\$ 60.00
2nd Place	\$ 38.00
3rd Place	\$ 30.00
4th Place	\$ 25.00
5th Place	\$ 20.00
6th Place	\$ 20.00
7th Place	\$ 20.00
8th Place	\$ 20.00
<b>Total</b>	<b>\$ 233.00</b>

**35 All Event**

1st Place	\$ 80.00
2nd Place	\$ 60.00
3rd Place	\$ 35.00
<b>Total</b>	<b>\$ 175.00</b>

**14 Senior Citizen All Event**

1st Place	\$ 42.00
<b>Total</b>	<b>\$ 42.00</b>



# Dixie Deaf Women Bowling Association

## Hall of Fame

Year	Receipient	Place
1982	Maggie Hipp*	Alabama
1983	Lynora Hogg*	Alabama
1984	N/A	
1985	Shirley Haggard*	Alabama
1986	Juanice Griffin	Georgia
1987	Mary Kasier	Kentucky
	Melba Desselle	Louisiana
1988	N/A	
1989	Jeanette Lorch	Georgia
1990	Dianell Butt	Alabama
1991	Martha Burnett*	Georgia
1992	Rose Maier*	Alabama
1993	Pauline Stephens	Alabama
1994	Elaine Bice	Alabama
1995	Maxine Sheffield*	Louisiana
1996	Teresia Wiley	Alabama
	Ellen Crochett	Louisiana
1997	Doris Berman	Florida
1998	Deanna Frederick	Alabama
1999	Anita Horne	Alabama
2000	N/A	
2001	N/A	
2002	Lana Booth	Alabama
2003	Pauline Laster	Maryland
2004	Syndey Beckman	Florida
2005	Darlene Carter	Kentucky
2006	Janet Ogden	Alabama
2007	Debbie White	West Virginia
2008	Mary Scott	Alabama
2009	Regina Ennis	West Virginia
2010	Ruby Losh	West Virginia
2011	Patty Brothag	Ohio
2012	Mary Ennis	West Virginia
2013	Barbie Phimmasone	West Virginia
2014	N/A	
2015	N/A	

\*Deceased

# Dixie Deaf Women Bowling Association

## HALL OF FAME POINTS

Last Name	First Name	Total
Martin	Polly	33
Mayhak	Wendy	33
Deville	Karen	32
Mayeaux	Sharon	31
Wagnor-White	Ann Marie	30
Hager	Karen	27
Blanks	Barbara	22
Stewart	Sherrie	22
Claytor	Rachele	21
Boshears	Norma	20
Shaw	Teresa	20
Henderson	Patricia	19
Mize	Sheri	19
McNally	Barb	18
Rogers	Robin Sue	18
Siarkowski	Bobbi	18
Thomas	Jamie	17
Smith	Karla	16
Clarke	Lauren	15
Leff	Donna	15
Reah Owens	Vicki	15
Tackett	Robin	15
Bryant	Martha	14
Kyle	Debra	14
Robillard	Cindy	14
Alman	Dawn	13
Boone	Trudy	13
O'Neill	Mo	13
Royers	Tina	13
Campbell	Rona	12
Chapman	Jeraldine	12
Fraychineaud	Dorothy	12
Newton	Diane	12
Dickerson	Roberta	11
Herzig	Elaine	11
Mounts	Angie	11
Cook	Paula	10
Hargis	Donna	10
Kingsmore	Pamela	10
Pope	Tammie	10
Ramser	Vicki	10
Turner	Gerry	10



# Dixie Deaf Women Bowling Association

## Team Events Records ~ Handicap

Year	Five-Woman	Score Pts	Year	Four-Women	Score Pts
1968	N.S.F.D Aux No. 146	TN 2995	1988	Southern Belle	LA/AL 2173
1969	Atlanta A.B. & C.D. No 1 GA	3001	1989	Motor Hand	OH 2143
1970	Maxey Gabbert & Co	AL 2841	1990	Central Iowa/Ill River	2101
1971	N/A		1991	Yellow Ribbons	WVA 2186
1972	N/A		1992	Atlanta Peaches	GA 2089
1973	N/A		1993	Nashville Assn of the Deaf	2266
1974	Kentucky Colonettes	KY 2463	1994	Cajun Queens	LA 2300
1975	<b>Cancelled to Deaf World Bowling</b>		1995	Maryland Crabs	MD 2176
1976	Atlanta 76	GA 2473	1996	Atlanta "96"	GA 2372
1977	N/A			GBAD-30's, 40's & 50's	2372
1978	All Hands	FL 2156		U of Kentucky	KY 2372
1979	Birmingham Ladies	AL 2187	1997	Goldschlaer Gals	TX 2372
1980	Birmingham Ladies	AL 2165	1998	Four Roses	AL 2290
1981	G. A. D. #1	GA 2199	1999	Internet Gals	WVA 2371
1982	Marylanders	MD 2360	2000	Internet Gals	WVA 2482
1983	Mid-South Bowling	TN 1697	2001	FADS	WVA 2537
1984	N/A		2002	Dixie Gals	AL 2336
1985	Texans	TX 2295	2003	Pin Busted	WVA 2286
1986	Rainbow Gals	FL 2215	2004	Shut up & Bowl	NJ 2657
1987	Busy Bees	KY 2206	2005	Internet Gals	WVA 2682
			2006	WVA Dixie 2008	WVA 2486
			2007	Greater B'mham Assoc/Deaf	2514
			2008	FADS	WVA 2457
			2009	ASL Power	WVA 2431
			2010	Greater B'mham Assoc/Deaf - No Problem	AL/WVA/IL 2635
			2011	HD Plingers	NC/AL 2412
			2012	Dixie 2016	PA/WVA 2417
			2013	Dixie 2014/2016	LA/WVA 2506
			2014	Left & Right Hand	AL/IL/TX 2481

# Dixie Deaf Women Bowling Association

## Double Events Records ~ Handicap

Year					Score Points
1968	Mary Kaiser	KY	J. Omeroso	New Albany	1251
	Betty Lawon	TN	Carol Hall	AL	1251
1969	Barbara Maser	TN	Maria Bomprezzi	TN	1255
1970	Wanda Booker	TN	Peggy Cooks	TN	1197
1971	N/A				
1972	Helen Kansky	FL	Gurtie West	AL	1279
1973	N/A				
1974	Mary Scott	AL	Shirley Haggard	AL	1252
1975	<b>Cancelled to Deaf World Bowling</b>				
1976	Shirley Bishop	AL	Vestalene Hill	AL	1239
1977	N/A				
1978	Rose Maier	AL	Dianell Butt	AL	1136
1979	Emie Stringer	AL	Elaine Bice	AL	1085
<b>1980</b>	<b>~ 1999 NO DOUBLES</b>				
2000	Angie Cosby	TN	Darlene Carter	KY	1222
2001	<b>NO DOUBLES</b>				
2002	<b>NO DOUBLES</b>				
2003	Cheryl Noschese	PA	Paula Tajc	PA	1230
2004	<b>NO DOUBLES</b>				
2005	Debra Schmidt	NJ	Lauren Clarke	NJ	1339
2006	Dawn Alman	MS	Debra Kyle	MS	1317
2007	Teresa Shaw	TN	Bobbi Siarkowki	MD	1290
2008	Teresia Wiley	AL	Mary Scott	AL	1251
2009	Vicki Owens	VA	Teresa Shaw	TN	1224
2010	Teresia Wiley	AL	Barbie Phimmason	WV	1352
2011	Lynn Crank	MD	Barbara Blanks	MD	1294
2012	Tine Coleman	MD	Barbara Blanks	Md	1294
2013	Sherrie Stewart	NC	Shelly Owens	NC	1259
2014	Martha Bryant	TN	Pauline Laster	MD	1242



## Dixie Deaf Women Bowling Association

### All Events Records ~ Handicap

Year	9-Games	Score Pts	Year	8-Games	Score Pts
1968	Jackie Omerio	1910	1980	N/A	1550
1969	Marie Bomprezzi	1939	1981	Penelope Hendee	1635
1970	Peggy Cooks	1771	1982	Peggy Wingert	1582
1971	N/A		1983	V. Walsh	
1972	Nina Strader	1835	1984	N/A	
1973	N/A		1985	Irene Pollock	1585
1974	Mary Scott	1843	1986	Elaine Ward	1545
1975	Cancelled to Deaf World Bowling		1987	Doris Bertram	1576
1976	Debbie Shelton	1999	1988	Janice Griffin	1561
1977	N/A		1989	Donna Hargis	1523
1978	Rose Maler	1766	1990	Darlene Carter	1478
1979	Shirley Bishop	1518	1991	Paty Sue Physa	1572
2000	Bethy Ethridge	1893	1992	Lorrie Murphy	1500
2003	Barbara McNally	1857	1993	Norman Boshears	1565
2005	Susan Garvey-Baker	2013	1994	Doris Moeshoff	1536
2006	Regina Ennis	1966	1995	Paula Cook	1634
2007	Karen Hager	2021	1996	Patty Brothag	1816
2008	Barbie Phimmasonone	2014	1997	Pat Hoffman	1648
2009	Mary Kesler	1863	1998	Joyce Krochta	1547
2010	Barbie Phimmasonone	2142	1999	Linda Flynn	1600
2011	Barbara Blanks	1941		Francine Ferrance	1600
2012	Ruby Losh	1901	2001	Patsy Tuttle	1735
2013	Gayle Willingham	1912	2002	Polly Martin	1640
2014	Claudia Briscoe	1949	2004	Sharon Mayeaux	1859

## Dixie Deaf Women Bowling Association

### Single Events Records ~ Handicap

Year	3-Games	Score Pts	Year	5-Games	Score Pts
1968	Mary Scott	630	1980	Alma Campbell	987
1969	Marie Bomprezzi	659	1981	J Smallwood	986
1970	Deanna Frederick	617	1982	Toni Sheffield	1030
1971	N/A		1983	M. Zisman	994
1972	Grace Frederickson	674	1984	N/A	
1973	N/A		1985	Jill Angrave	991
1974	Vestalene Timms	61	1986	Barbara Mongeau	962
1975	Cancelled to Deaf World Bowling		1987	Anita Home	992
1976	Debbie Shelton	677	1988	Doris Bertram	960
1977	N/A		1989	Teresta Willey	995
1978	Debbie Shelton	616	1990	Ruth Slater	960
1979	Sharon Bell	583	1991	Darlene Carter	986
2000	Becky Ethridge	663	1992	Lorie Murphy	1019
2003	Barbara McNally	679	1993	Betty Manion	981
2005	Sue George	695	1994	Karla Smith	959
2006	Elaine Bice	682	1995	Paula Cook	1051
2007	Jamie Thomas	697	1996	Patt Brothag	1197
2008	Barbie Phimmasonone	688	1997	Pat Hoffman	1103
2009	Mary Kesler	671	1998	Huey Sue Robert	953
2010	Barbie Phimmasonone	697	1999	Kren Tarnelli	1011
2011	Trudy Boone	680	2001	Patsy Tuttle	1113
2012	Ruby Losh	659	2002	Polly Martin	1052
2013	Wendy Mayhak	729	2004	Sharon Mayeaux	1159
2014	Claudia Briscoe	684			

## Dixie Deaf Women Bowling Association

### Senior Citizen All Events Records ~ Handicap

Year	Above 62 Years	Score Pts	Year	Above 55 Years	Score Pts
1989	P. Lauve	1407	1995	Barbara Vincent	1529
1990	Hazel McFadden	1361	1996	Juanice Griffin	1624
1991	Maggie Hipp	1374	1997	Pat Hoffman	1648
1992	Meilba Desselle	1345	1998	Doris Berman	1485
1993	Maggie Hipp	1507	1999	Yvonne Esquibel	1553
1994	Barbara Vincent	1406	2000	Yvonne Esquibel	1880
			2001	Elaine Bice	1688
			2002	Elaine Herzig	1522
			2003	Elaine Herzig	1573
			2004	Darlene Carter	1791
			2005	Susan Liese	1952
			2006	Regina Ennis	1966
			2007	Jeraldine Chapmail	1988
			2008	Darlene Carter	1812
			2009	Regina Ennis	1795
			2010	Luci Ryan	2042
			2011	Trudy Boone	1940
			2012	Teresa Wiley	1764
			2013	Debbie White	1825
			2014	Martha Bryant	1814

## Dixie Deaf Women Bowling Association

### Maggie Hipp Queen Records ~ Handicap

Year	Score Pts	Year	Score Pts
1979	1459	1979	1422
1980	1550	1980	1483
1981	1404	1983	1300
1982	1345	1985	1258
1983	1618	1987	1690
1984	1898	1988	1822
1985	1284	1989	1319
1986	1321	1990	1241
1987	1273	1991	1266
1988	1559	1992	1492
1989	1299	1993	1297
1990	749	1994	686
1991	1353	1995	1344
1992	1667	1996	1632
1993	1359	1997	1350
1994	1582	1998	1618
1995	786	1999	766
1996	1566	2000	1530
1997	1569	2001	1672
1998	1558	2002	1398
1999	2168	2003	1714
2000	1590	2004	1589
2001	1344	2005	1687
2002	1542	2006	1873
2003	1488	2007	1857
2004	1281	2008	1262
2005	1833	2009	1480
2006	1465	2010	1650
2007	1665	2011	2111
2008	1860	2012	1458
2009	1047	2013	1418
2010		2014	

### RUNNER-UP

Year	Name	State
1979	Anita Horne	AL
1980	Gloria Tunstell	KY
1981	Rose Maier	AL
1982	F. Williams	OH
1983	Cynthia Graham	TX
1984	Shirley Haggard	
1985	Lindy Brooks	
1986	Irene Pollock	
1987	Martha Burnett	GA
1988	Maggie Hipp	AL
1989	Donna Hargis	TN
1990	Elaine Bice	AL
1991	Syndey Beckman	FL
1992	Dianeil Butt	AL
1993	Norman Boshears	TN
1994	Ada Berry	AR
1995	Sharon Mayeaux	LA
1996	Janet Ogden	GA
1997	Karen McClanahan	KS
1998	Joyce Krochat	IN
1999	Susan Sultan	OK
2000	Pauline Laster	MD
2001	Polly Martin	AL
2002	Polly Martin	AL
2003	Tina Royers	FL
2004	Mary Ennis	WV
2005	Lauren Clarke	NJ
2006	Jeraldine Chapmail	
2007	Ruby Losh	WV
2008	Mo O'Neill	NC
2009	Bobbi Siarkowski	MD
2010	Rachele Claytor	AL
2011	Barbara Blanks	MD
2012	Allison Bazzle	NC
2013	Ruby Losh	WVA
2014	Rachele Claytor	AL

### CHAMPION

Year	Name	State
1979	Martha Leach	
1980	Shirley Bishop	AL
1981	Maggie Hipp	AL
1982	P. Hendee	IL
1983	Shirley Haggard	AL
1984	Juanice Griffin	GA
1985	Shirley Haggard	AL
1986	Ruby Baxtor	NC
1987	Mandy Barber	
1988	Deanna Frederick	AL
1989	Ruby Baxtor	NC
1990	Doris Berman	FL
1991	Diane Newton	NC
1992	Elaine Bice	AL
1993	Betty Mantion	MO
1994	Robin Sue Rogers	GA
1995	Melaine Smith	TX
1996	Aileen Saunders	MI
1997	Karen Deville	LA
1998	Darlene Carter	KY
1999	Darlene Carter	KY
2000	Sheri Mize	TX
2001	Samantha Martin	AL
2002	Sharon Mayeaux	LA
2003	Wendy Mayhak	IL
2004	Syndey Beckman	FL
2005	Wendy Mayhak	OK
2006	Mary Kesler	WV
2007	Angie Mounts	TN
2008	Barbara Blanks	MD
2009	Teresa Wiley	AL
2010	Barbie Phimmason	WV
2011	Trudy Boone	NC
2012	Ruby Losh	WV
2013	Sherrie Stewart	NC
2014	Linda McKay	PA



# WE ARE SUPPORT



**LOUISVILLE**

**SILENT**

**BOWLING**



**CLUB**

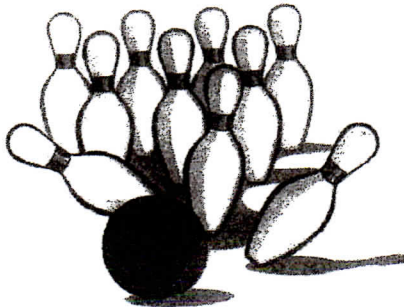

**THOMAS SMITH  
AND  
SUZANNE MAYES**

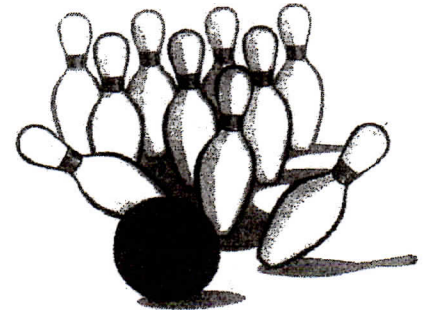

**DIXIE DEAF BOWLING ASSOCIATION  
AND  
DIXIE DEAF WOMEN BOWLING ASSOCIATION**

**GOOD LUCK & BEST WISHES  
TO  
ALL BOWLERS!**

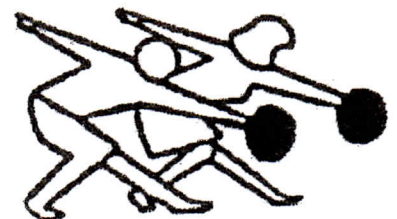
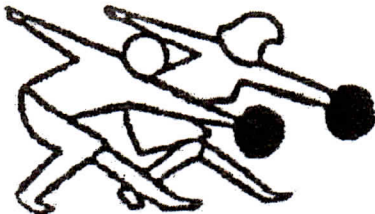



# 5th Annual

## South Deaf Mixed Bowling Association

**Hosted by: Tiger Deaf Mixed Bowling**

**Saturday, August 6, 2016  
AMF All Star Lanes  
9829 Airline Hwy.  
Baton Rouge, Louisiana 70816**

**President: Tommy Daughtery 205-386-8470 Vp  
Vice President Debra Kyle 769-232-4245 Text  
Secy/Treas.: Richard Wiley 205 543-5010 Vp**

**Chairperson: Mike Landry - 225-341-6347  
TDMB Committees**

**Friday, August 5, 2016**

**7:00 Meeting**

**at AMF All Star Lanes**

**Saturday, August 6, 2016**

**10:00 am Team Events**

**1:00 pm Single Events**

**Saturday Award Night**

**7:00 pm**



**Fans:**

**\$10.00 per Adult w/10 tickets**

**Under 17 yrs old: Free**

**(no tickets )**

**Extra buy tickets for \$5.00**

**For information on Entry Forms, Please contact Richard Wiley at [SDMBA2012@aol.com](mailto:SDMBA2012@aol.com)**



# LOUISVILLE SILENT BOWLING CLUB

2015



## OFFICERS

PRESIDENT: ROLAND FAIRFAX

VICE PRESIDENT: LEE POLLARD

TREASURER: DONALD McMONIGLE

SECRETARY: TAMMY EATON

DIRECTOR: 1) PEARLINE MOLET

DIRECTOR: 2) SUZANNE MAYES

DIRECTOR: 3) JEANI TUCKER

DIRECTOR: 4) ROBERT ARMSTRONG

TRUSTEE: 1) RICKY SPURLOCK

TRUSTEE: 2) OSCAR HAMILTON

TRUSTEE: 3) MARK HUNT

WOMEN MEMBER \$17.00 -- MEN \$21.00 MEMBER  
IN SILENT MIXED LEAGUE INCLUDE FREE MEMBER  
FOR LOUISVILLE SILENT BOWLING CLUB

BOWLER SUB MEMBER IN OUR LEAGUE AND WANT JOIN OUR L.S.B.C. MEMBER \$5.00

IF BOWLER NOT JOIN OUR LEAGUE AND WANT TO OUR L.S.B.C. MEMBER \$8.00

IF NON BOWLER WANT TO HELP FOR LOUISVILLE SILENT BOWLING CLUB

MEMBER \$10.00 UNDERSTAND CANT VOICE ANF NO VOTE

30th ANNIVERSARY  
DECEMBER 14, 1984

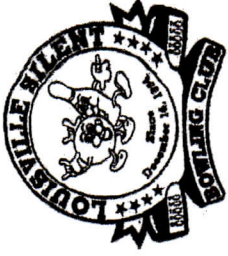

# SILENT MIXED TRIO LEAGUE

2014 - 2015

## OFFICERS

PRESIDENT: LEE POLLARD

VICE PRESIDENT: DONALD McMONIGLE

TREASURER: ROLAND FAIRFAX

SECRETARY: ROLAND FAIRFAX

SERGEANT - AT - ARMS: MARK HUNT

1991 - 1998 7 YEARS SILENT MIXED TRIO LEAGUE 8th YEARS 2014 - 2015

1998 - 2014 17 YEARS SILENT MIXED DOUBLES LEAGUE

TREASURER & SECRETARY ROLAND FAIRFAX FOR 25 YEARS

# BOOSTERS

THANK YOU, YOUR PATRONAGE WHICH IS VERY MUCH APPRECIATED

GERALDINE LEWIS  
JAMES M LAMBERT  
CHARLOTTE THOMAS  
JOHNNY R GRAY  
DELMAS WOODALL  
PAUL HOCKER  
TOM VASAS  
LORI POPE  
SPENEER WILLEY  
SHAWN McELMEEL  
ROBERT BILLINGSLEA  
JACKIE ROBINSON  
JAMES " MIKE" FAIRCHILD  
RONNIE SIMMONS  
WILLIAM J FROHN  
JAMES ENNIS  
JASON HARRISON  
VERANDA HARRISON  
EMANVEL ROBINSON (2)  
BARBARA S OWENS  
WARREN BURFORD  
BOBBY DUNCAN  
BRUCH FARMER  
LARRY NEWTON  
JIM LOMANTO  
SHARON DITONDO  
SANDRA HATIBOVIC  
JOSEPH BELFORD  
JAMES DUDASIK  
SHEILA HAJDUK  
SUSAN GONZALES  
KARLA CAMPO  
CARLOS P ACEVEDO  
CARLOS ACEVEDO  
DALE THOMPSON  
AARAN LARGEVEW  
CARMEN FALCON  
GINA MAKEY  
KYLE CLEMENS  
CINEH PATT

JOSH BALLENGEE  
GERALD MUSICK  
LACY BROWN  
HELE BERRY  
ANGELA SMITH (4)  
SUSAN HOCKER  
WILLIAM GRAVES  
CHEIS SHIELDS  
JERALDINE CHAPMAN  
KEN MURRY  
CAROUE SUE CHAZEN  
DONNA WILLIAMS  
EMILY D FAIRCHILD  
PATRICIA SIMMONS  
MARY ENNIS  
MARY ENNIS  
SHARN DRAKE  
EMILY FAIRHIL  
LYNN LIGHTNER (4)  
GERRI JOHSON  
STEVE BURFORD  
JACK O' ROURKE  
MIKE SHIELDS  
URMARDO GAZALE  
CHARLENE LOMANTO  
TINA TERRANCE  
SARA ANN LANDRY  
PHILIP MILLS  
COREY BLACKWELL  
KAREN HAGER  
CRAIG SCHLORFF  
EDMOND HOBERG  
DANNIEL BAYS  
CAROL NEMECEK - KOWALSKI  
ALICE THOMPSON  
TERRY WALKER  
NADINE GOBIE  
BILLY DOWNING  
PERICK CLOUN  
RON HAYES

MISSY BANE  
JEFFERY W SIMMORS  
KEVIN S ROGERS  
NADA WHITE  
LISA GRAY  
BRANDY DAVIS  
WALTER GRIFFIN JR.  
CHRISTIE SCOTTANC  
JOHN McELMEEL(2)  
DARLEN LEWIS  
DALTON HARRISON  
JOEY MAJOR  
TERRY BIRD  
JULIE SIMMONS  
REGINA ENNIS  
TAMMY ENNIS  
LARRY G HUBBARD  
HAROLD LOGAN  
WALTER LEE LEWIS  
HAROLD COOKER  
BILLY ED MELVIN  
DAVID FATELY  
ROBERTVBRODOWSKI  
MICHAEL PASQUALE  
JAMES NICHELSON  
JOHNNY BOY  
MIKE WAYNE LANDRY  
STEVE RUIZ  
GORDON SENC SOC SR.  
MARK FEDER  
JAM O'HEA  
LINDA MEDIEN  
DARREN BARTH  
DJ2DEF - IND.  
PAUL KUPLICKI JR.  
ORLANDO FALCON  
KEITH M MAKEY  
KEN DE GROFF  
SUE HOFMANN  
BEAN HENDRICH



# LOUISVILLE SILENT BOWLING CLUB

## INDIVIDUAL HANDICAP BOWLING TOURNAMENT

### PAST CHAMPIONSHIP

#### KENTUCKY MIXED TAP 9

1986 1st THOMAS WEBB SR.  
 1987 2nd ROLAND FAIRFAX  
 1988 3rd ROLAND FAIRFAX  
 1989 4th TONI SHEFFIELD  
 1990 5th ROLAND FAIRFAX  
 1991 6th THOMAS WEBB SR.  
 1992 7th TONI SHEFFIELD  
 1993 8th EUGENE LOCKARD  
 1994 9th EUGENE LOCKARD  
 1995 10th ROLAND FAIRFAX  
 1996 11th DONALD McMONIGLE  
 1997 12th ROLAND FAIRFAX  
 1998 13th EUGENE LOCKARD  
 1999 14th JUTTA BENTON  
 2000 15th ROLAND FAIRFAX  
 2001 16th ROLAND FAIRFAX  
 2002 17th ROBERT ARMSTRONG @  
 2003 18th MICHAEL GRAY @  
 2004 19th MATTHEW GARDNER @  
 2005 20th ROLAND FAIRFAX @  
 2006 21st DANNY POOL @  
 2007 22nd ROLAND FAIRFAX @  
 2008 23rd ROLAND FAIRFAX @  
 2009 24th DIERDRE ALKIRE @  
 2010 25th ROLAND FAIRFAX @  
 2011 26th THOMAS SMITH  
 2012 27th ROBERT ARMSTRONG  
 2013 28th ROLAND FAIRFAX  
 2014 29th MARK HUNT  
 2015 30th AUGUST 15, 2015  
 AT RICHMOND, KY.

#### ANNIVERSARY MIXED TAP 9

1985 1st EUGENE LOCKARD  
 1986 2nd THOMAS WEBB, SR.  
 1987 3rd ROLAND FAIRFAX  
 1988 4th ROLAND FAIRFAX  
 1989 5th EUGENE LOCKARD  
 1990 6th BENNY ENGLE  
 1991 7th ROLAND FAIRFAX  
 1992 8th EUGENE LOCKARD  
 1993 9th LINDA GOOD  
 1994 10th THOMAS WEBB, SR.  
 1995 11th DONALD McMONIGLE  
 1996 12th DONALD McMONIGLE  
 1997 13th EUGENE LOCKARD  
 1998 14th NATHAN BENTON  
 1999 15th ROBERT ARMSTRONG  
 2000 16th ROLAND FAIRFAX  
 2001 17th ROLAND FAIRFAX  
 2002 18th JEFF CECIL @  
 2003 19th ROLAND FAIRFAX @  
 2004 20th NATHAN BENTON @  
 2005 21st DANNY POOL @  
 2006 22nd DANNY POOL @  
 2007 23rd ROLAND FAIRFAX @  
 2008 24th ROLAND FAIRFAX @  
 2009 25th ROLAND FAIRFAX @  
 2010 26th ROBERT ARMSTRONG @  
 2011 27th ROBERT ARMSTRONG  
 2012 28th ROLAND FAIRFAX  
 2013 29th OSCAR HAMILTON  
 2014 30th JEANI TUCKER  
 2015 31st DECEMBER 5, 2015  
 AT CLARKSVILLE, IND.

#### L.S.B.C. MIXED TAP 9

1990 1st GEORGE TUNSTALL III  
 1991 2nd ROLAND FAIRFAX  
 1992 3rd ROLAND FAIRFAX  
 1993 4th GEROLD BUCKINGHAM  
 1994 5th EUGENE LOCKARD  
 1995 6th ROLAND FAIRFAX  
 1996 7th EUGENE LOCKARD  
 1997 8th DONALD McMONIGLE  
 1998 9th EUGENE LOCKARD  
 1999 10th ROLAND FAIRFAX  
 2000 11th ROLAND FAIRFAX  
 2001 12th WILLIAM COOMER  
 2002 13th ROBERT ARMSTRONG  
 2003 14th ROLAND FAIRFAX @  
 2004 15th ROLAND FAIRFAX @  
 2005 16th ROLAND FAIRFAX @  
 2006 17th BRENDA DeWITT @  
 2007 18th RONALD BARIL @  
 2008 19th LISA GIBBS @  
 2009 20th ROLAND FAIRFAX @  
 2010 21st ROBERT ARMSTRONG @  
 2011 22nd CHRISTOPHER SHIELD @  
 2012 23rd ROLAND FAIRFAX  
 2013 24th ROLAND FAIRFAX  
 2014 25th ROLAND FAIRFAX  
 2015 26th LEE POLLARD / DIERDRE ALKIER  
 MEN'S WOMEN'S  
 2016 27th APRIL 23, 2016  
 AT LOUISVILLE, KY.

#### LOUISVILLE DERBY MIXED TAP

1987 1st ROLAND FAIRFAX  
 1988 2nd MICHAEL GRAY  
 1989 3rd HARRY SHEFFIELD  
 1990 4th WILLIAM GULLEY  
 1991 5th TERRY PERDUE  
 1992 6th EUGENE LOCKARD  
 1993 7th PATTY LOCKARD  
 1994 8th LINDA GOOD  
 1995 9th NATHAN BENTON  
 1996 10th ROLAND FAIRFAX  
 1997 11th ROLAND FAIRFAX  
 1998 12th THOMAS WEBB, SR.  
 1999 13th ROBERT ARMSTRONG  
 2000 14th ROLAND FAIRFAX  
 2001 15th ROLAND FAIRFAX  
 2002 16th ROLAND FAIRFAX  
 2003 17th ROLAND FAIRFAX @  
 2004 18th MICHAEL GRAY @  
 2005 19th ROLAND FAIRFAX @  
 2006 20th TOMMY WIMSATT @  
 2007 21st ROLAND FAIRFAX @  
 2008 22nd ROLAND FAIRFAX @  
 2009 23rd ROLAND FAIRFAX @  
 2010 24th DIERDRE ALKIRE @  
 2011 25th THOMAS SMITH  
 2012 26th THOMAS SMITH  
 2013 27th OSCAR HAMILTON  
 2014 28th OSCAR HAMILTON  
 2015 29th ROLAND FAIRFAX  
 2016 30th MAY 21, 2016  
 AT CLARKSVILLE, IND.

@ IN LEAGUE

## 2015 - 2016

### LOUISVILLE SILENT BOWLING

### BOWLING TOURNAMENT SCHEDULE

#### 2015 - 2016

**AUGUST 15, 2015**  
**OCTOBER 10, 2015**  
**DECEMBER 5, 2015**  
**JANUARY 16, 2016**  
**FEBRUARY 20, 2016**  
**MARCH 5, 2016**  
**APRIL 23, 2016**  
**MAY 21, 2016**

**30th KENTUCKY MIXED TAP 9 (8 TOP)**  
**4th EASTERN KENTUCKY MIXED TAP 9 (5 TOP)**  
**31st ANNIVERSARY MIXED TAP 9 (5 TOP)**  
**2nd LOUISVILLE CARDINALS MIXED TAP 9 (5 TOP)**  
**3rd SOUTHERN INDIANA TAP 9 (5 TOP)**  
**5th KENTUCKY COLONEL'S MIXED TAP 9 (8 TOP)**  
**27th L.S.B.C. MIXED TAP 9 (5 TOP)**  
**30th LOUISVILLE DERBY MIXED TAP 9 (8 TOP)**

**RICHMOND, KY.**  
**RICHMOND, KY.**  
**CLARKSVILLE, IND.**  
**LOUISVILLE, KY.**  
**CLARKSVILLE, IND.**  
**RICHMOND, KY.**  
**LOUISVILLE, KY.**  
**CLARKSVILLE, IND.**



# 66<sup>th</sup> Annual MEN and 49<sup>th</sup> Annual WOMEN DIXIE DEAF BOWLING ASSOCIATION

May 26-29, 2016

Host by  
Fairmont Association of the Deaf Sports  
Fairmont, West Virginia

## HOTEL HEADQUARTER

### & SOCIAL NIGHTS

Wingate by Wyndham  
350 Conference Center Way  
Bridgeport, WV 26330  
304-808-1000

Rate: \$109.00 plus tax

Group Code: CGFADS

Cut Off Date: April 29, 2016

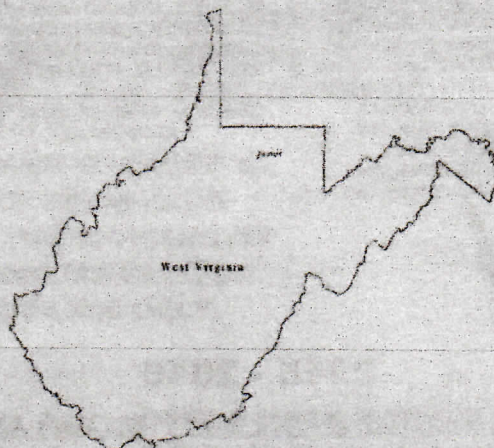

### DDBA

Secretary/Treasurer  
Lawson McNally  
100 N. River Drive  
Morganton, NC 28655-9881  
VP: 828-475-0654  
[LawDeb2@aol.com](mailto:LawDeb2@aol.com)  
[www.n-ski.com/DIXIE](http://www.n-ski.com/DIXIE)

### DDBA

Bowling Center  
Compton Lanes  
1203 East Pike  
Clarksburg, WV 26301  
304-622-1261

### FAN COMBO

\$30.00

Refundable by May 1, 2016

Payable to: FADS/DIXIE

Gerald Musick  
151 Lincova Avenue  
Morgantown, WV 26505  
VP: 304-212-2295  
[musice@comcast.net](mailto:musice@comcast.net)

EXCITING TO  
DO IN WV!

[www.wv.gov](http://www.wv.gov)

### DDWBA

Secretary/Treasurer  
Patricia Henderson  
4640 Twilight Cove  
Peal, MS 39208-3914  
VP: 601-206-0079  
[ddwba12@aol.com](mailto:ddwba12@aol.com)  
<https://sites.google.com/site/ddbaddwba/home>

### DDWBA

Bowling Center  
Fairmont Bowling Center  
1 Kirkway Drive  
Fairmont, WV 26554  
304-366-0631

### For More Information

Chairperson, Ruby Losh

VP: 304-816-0658

[losh.ruby@gmail.com](mailto:losh.ruby@gmail.com)



Fairmont Association  
of the Deaf

<https://sites.google.com/site/wvsdaa/wv-deaf-events>

## FAN COMBO REGISTRATION

Name: \_\_\_\_\_

Address: \_\_\_\_\_

City: \_\_\_\_\_ State: \_\_\_\_\_ Zip Code: \_\_\_\_\_

VP: \_\_\_\_\_ E-mail: \_\_\_\_\_

\_\_\_\_\_ Person(s) x \$30.00 = \_\_\_\_\_ Money Order or Cashier Check or Cash only

Payable to: FADS/DIXIE **NO PERSONAL CHECK** Send to Gerald Musick  
151 Lincova Avenue, Morgantown, WV 26505